

# BD FACSCalibur



Helping all people  
live healthy lives

The flow cytometer for your  
routine cell analysis needs



# A system with a rich application basis and a modular approach that continues to meet evolving needs of cell analysis worldwide.

The BD FACSCalibur™ platform offers a unique modular approach to flow cytometry and allows users to perform both cell analysis and cell sorting in an innovative single bench-top system. Designed with multicolor application support in mind, the BD FACSCalibur flow cytometer provides flexibility to support a wide variety of research and clinical applications.

Engineered to meet evolving clinical and research requirements, the user-friendly BD FACSCalibur system can be easily upgraded to address emerging automation or sorting requirements in a laboratory. Walkway automation can be achieved by the BD FACST™ Loader option that handles tube-based assays or the BD™ High Throughput Sampler that handles assays in 96 or 384-well microtiter plates.\* In addition, the BD FACSCalibur system can be upgraded to support cell sorting to allow for the isolation of a population of interest.\*

Built-in modularity and simple upgrades make the BD FACSCalibur an excellent long-term investment for today's cost conscious laboratories.

The BD FACSCalibur system is compact and easy to use. It is complemented by a broad suite of intuitive software solutions to streamline analysis for a wide range of applications, including enumeration of lymphocyte subsets, stem cells, residual white blood cells, reticulocytes, DNA analysis,\* immune function studies,\* bead based immunoassays,\* and multiplexed analysis of signal transduction\* and phosphorylation targets.\*

**Enabling fast, easy, and accurate results for routine applications with a versatile, modular design has made the BD FACSCalibur the automated benchtop cytometer of choice for cell analysis in research and clinical laboratories worldwide.**

# Performance and simplicity when it counts

The BD FACSCalibur is a fully integrated multiparameter system that has the performance and sensitivity to ensure objective and reproducible results vital to laboratories worldwide.

### Optical path configuration

Flow cytometry has evolved rapidly to incorporate the use of multiple fluorochromes to effectively identify and isolate subset populations in a single sample. This maximizes the information gained from limited samples and makes the assays more cost effective.

The first system to provide standard multicolor analysis capabilities with the use of dual-laser technology, interbeam compensation, and an alignment free optical design, the BD FACSCalibur system ensures high sensitivity, minimal compensation, and maximum flexibility in choice of fluorochromes.

This high performance system is a valued tool worldwide for routine cell analysis, assay development, verification, and identification of cellular populations of interest.

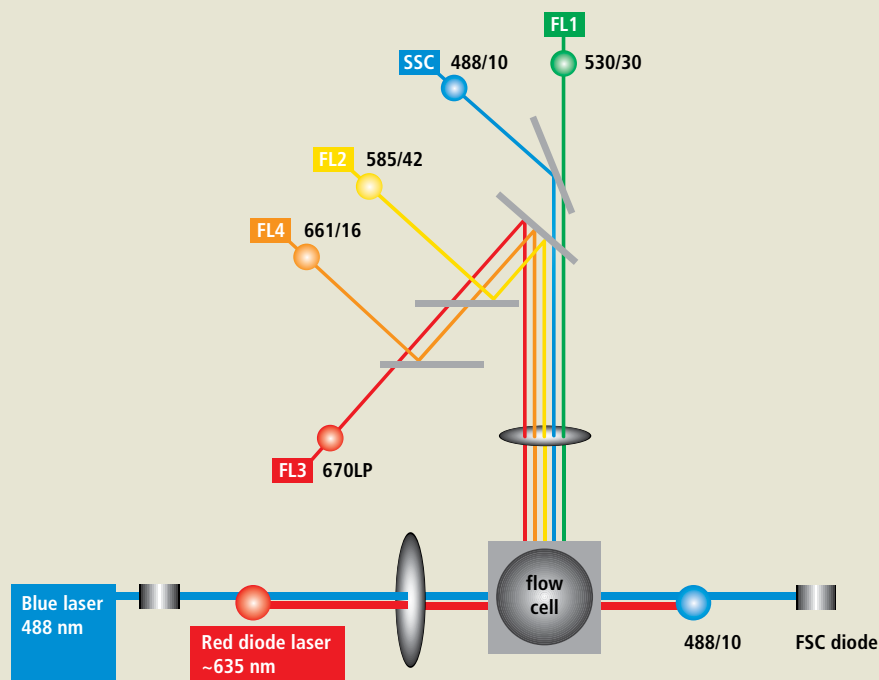

BD FACSCalibur optical path configuration

### Rare-event analysis

A growing number of flow cytometry-based assays depend on rare-event detection. For example, in the characterization of subpopulations of stem cells, millions of cells are analyzed to achieve a statistically significant sampling of the subset of interest. Advanced applications like this require a flow cytometer capable of high-speed analysis. The BD FACSCalibur system features a multiparameter triggering system that allows a user to accelerate the analysis by electronically eliminating events from onboard processing.

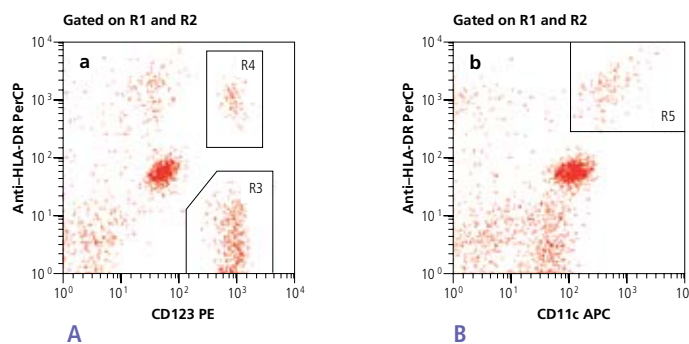

- A Region R3 defines basophils and region R4 defines CD123<sup>+</sup> DCs (0.14% of total).
- B Region R5 defines CD11c<sup>+</sup> DCs (0.21% of total).

# RESULTS

## Dual-laser design for multicolor analysis

The BD FACSCalibur dual-laser design provides the flexibility and sensitivity needed for multicolor analysis. Two lasers, an air-cooled argon laser and a red diode laser, are spatially separated for high sensitivity, minimal compensation, and maximum flexibility in fluorochrome selection. This maximizes the information obtained from limited samples and increases the cost-effectiveness of each assay.

A fully integrated multiparameter system, the BD FACSCalibur system ensures objective and reproducible results, which are vital to today's laboratories.

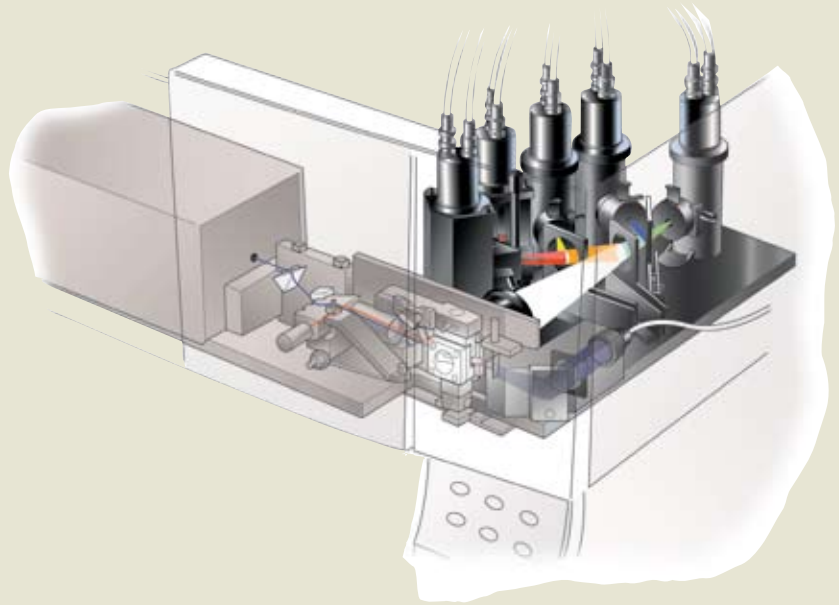

BD FACSCalibur optical bench

## Unique easy-to-use sorting technology (optional)

The BD FACSCalibur cell sorting option allows users to identify and isolate a population of interest. Sorting on the BD FACSCalibur system occurs in a completely enclosed, aerosol-free environment for enhanced safety, which is especially important when processing biohazardous samples. The sorting process is designed to be straightforward. After the population of interest is gated, simply click "Acquire" to begin the sort. After the sample is acquired and cells pass through the laser, a unique catcher tube mechanism moves in and out of the sample core stream at a rate of roughly 300 times per second to capture designated cells and direct them to a collection tube or to an optional cell concentrator module for further processing. *(The BD FACSCalibur cell sorting and cell concentrator options are for Research Use Only)*

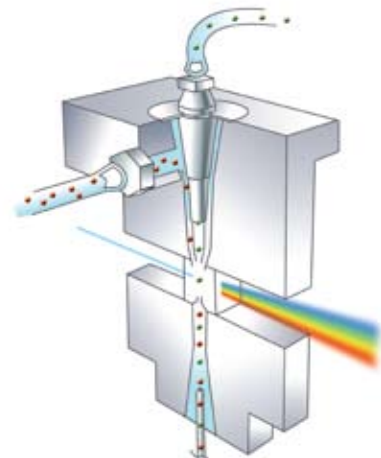

BD FACSCalibur sorting mechanism

## Flexibility for sample introduction and enhanced productivity

### BD FACS Loader option

The BD FACS Loader option available for the BD FACSCalibur system provides walkaway automation for routine applications. Featuring a removable 40-tube carousel, onboard mixing, and BD™ Worklist Manager software, the BD FACS Loader option offers superior flexibility to efficiently address the workflow demands of the busy laboratory.

### BD High Throughput Sampler (HTS) option

The BD High Throughput Sampler (HTS) option provides flexible, easy-to-use automation. For those who prefer to work with multiwell plates, BD Biosciences offers the first walkaway sample introduction device for 96- and 384-well plates. The HTS option allows users to rapidly acquire samples with the BD FACSCalibur flow cytometer in a microtiter plate. As a modular option for new or existing BD FACSCalibur flow cytometers, the HTS option is designed to speed through a variety of microtiter plates in less than 15 minutes\* and support a wide range of applications including the BD™ Cytometric Bead Array assay. The HTS option supports 96 U-, V-, and flat-bottom plates as well as 384-well microtiter plates.

BD™ Plate Manager software allows you to create customized delivery protocols to be used repeatedly with user-defined mixing, wash, and analysis parameters. *(The BD High Throughput Sampler option and BD Plate Manager are for Research Use Only)*

\* Based on a 2-second sample acquisition.

### Efficient residual white blood cell enumeration

The BD Leucocount™ system is the first automated, IVD-cleared product for monitoring leucoreduced blood products. Together with BD Trucount™ tubes and BD Leucocount process controls, the BD Leucocount system provides excellent accuracy, precision, and linearity. For high-throughput walkaway capability, the BD FACS Loader can also be added to your base BD FACSCalibur system.

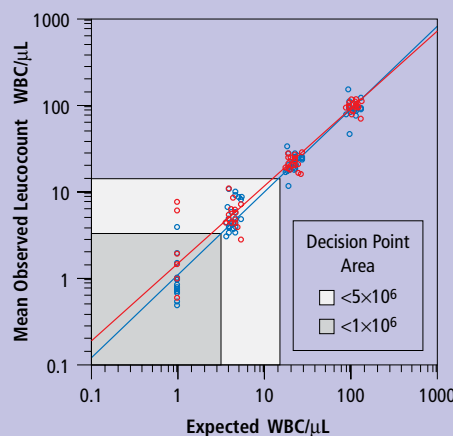

### BD Leucocount kit

The BD Leucocount system provides excellent accuracy, precision, and linearity at clinically significant levels of detection for RBC (red) and platelet (blue) samples.

### Immunophenotyping

Characterizing cells at different stages of development through the use of fluorescent-labeled monoclonal antibodies against surface markers is one of the most common applications of flow cytometry. The BD FACSCalibur system provides multicolor capability in an easy-to-use system. Instrument setup is as easy as the push of a button and a click of the mouse. Efficient collection optics, coupled to the flow cell with an optical gel, permit the use of a low-powered, air-cooled argon laser and a red diode laser to ensure the high sensitivity required for analysis of low-density antigens.



### Accurate absolute counts with BD Trucount technology

BD Trucount tubes make single-platform absolute counting easy—no syringes, additional pipetting steps, or need to integrate data from another analyzer. Designed for use with clinical products such as BD Multitest™ and BD Tritest™ lymphocyte subsetting reagents, BD Leucocount rWBC assay kit, BD Trucount tubes bring precision to cell counts and improved productivity. For research applications, BD liquid counting beads are also available within the BD Cell Viability kit for quick estimations of cell cultures or bacterial concentrations. *(The BD Cell Viability kit is for Research Use Only)*

Display of analysis for a sample prepared with BD Multitest reagents in a BD Trucount tube using the lyse/no-wash protocol in BD Multiset™ software.

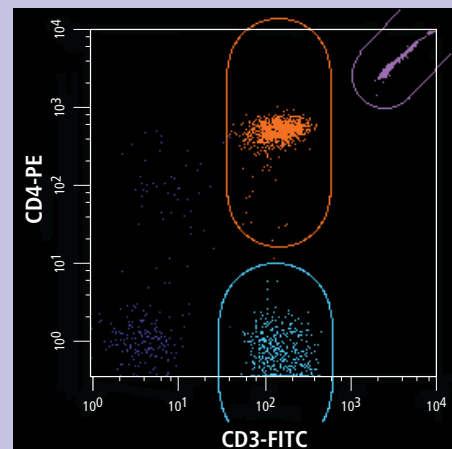



## Delivering results with a powerful, easy-to-use data management system

The BD FACSCalibur system is appreciated for its user-friendly design, high sample throughput, improved workflow management through automation, and simple yet sophisticated software applications that enhance routine analyses.

While performing any of a wide range of supported applications, the BD FACSCalibur system provides the tools to obtain results quickly, easily, and accurately.

The ease-of-use of the BD FACSCalibur system is enhanced by the BD FACStation™ data management system that has become one of the most popular, user-friendly data management systems in flow cytometry. The BD FACStation system automates many software functions and delivers high-performance acquisition and analysis tools for creating plots, gating, statistical analysis, and reporting.

The BD FACStation workstation takes advantage of the intuitive Mac® environment by using simple pull-down menus and icons. It performs all the computing tasks required for fast, accurate results including instrument setup, as well as data collection, analysis, and management.

### A comprehensive quality assurance system

BD Biosciences offers a complete family of products designed to ensure the highest quality clinical results from the BD FACSCalibur system. BD FACSComp™ software, in conjunction with BD Calibrite™ beads, provides a comprehensive system to set up the instrument, assess sensitivity, and set compensation for immunofluorescence applications. For clinical applications, BD Biosciences offers a wide variety of cellular controls to verify performance for immunophenotyping, reticulocyte analysis, stem cell enumeration, and rWBC applications.

### DNA Analysis

The BD FACSCalibur system works together with BD DNA analysis quality control products to eliminate many of the variables associated with ploidy and cell-cycle analysis. The instrument's optical and fluidic design ensures that high-resolution DNA ploidy and S-phase determinations are easy to achieve. Electronic doublet discrimination, using the area and width of the fluorescence pulse, allows for the removal of artifacts—doublets and aggregates—from the analysis. High-resolution electronics and linearity ensure accurate results. To ensure optimal performance, BD DNA QC products, including fixed cells and fluorescent particles, can be used for setup, verification of the doublet discrimination module, and monitoring daily operation. *(BD DNA Analysis products are for Research Use Only)*

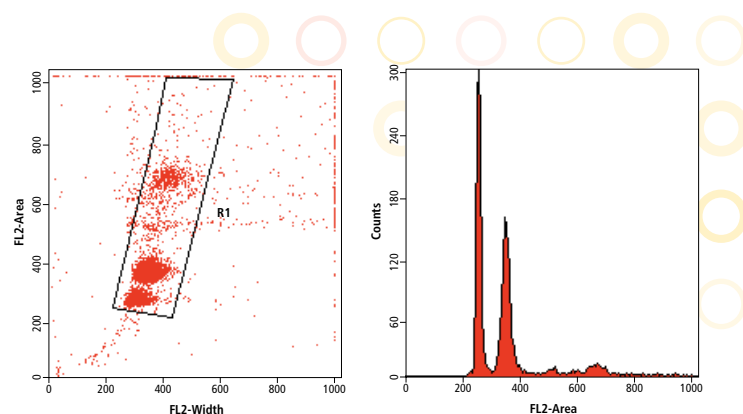

### DNA analysis

Pulse processing is a powerful tool used in the discrimination of doublets for optimal DNA analysis.



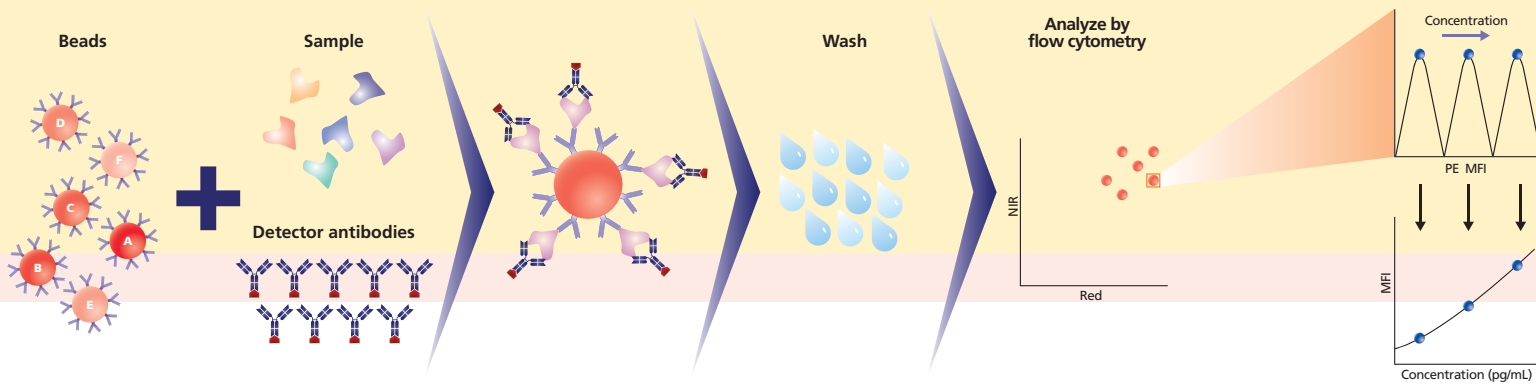
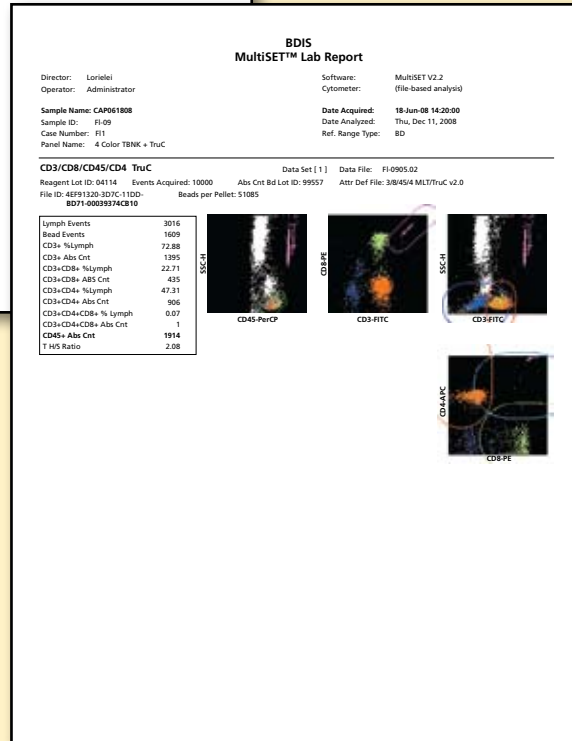
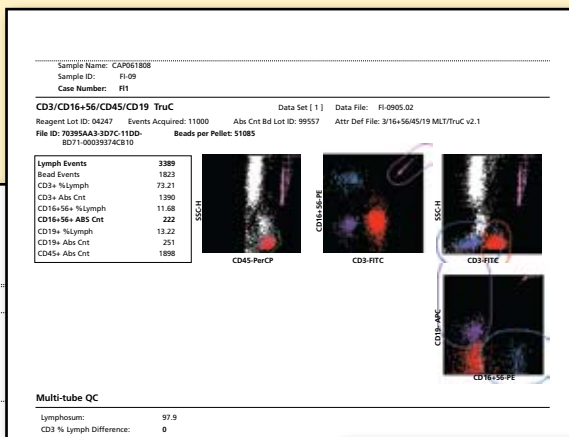
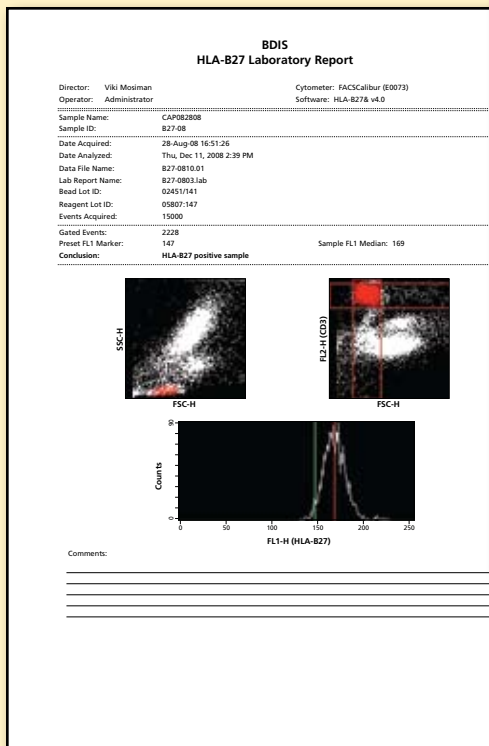

#### BD Cytometric Bead Array assays

The BD FACSCalibur flow cytometer can be used to acquire data from BD Cytometric Bead Array (CBA) multiplexed assays. These assays are powerful, flexible tools that simultaneously quantify multiple cytokine, chemokine, immunoglobulin,

or cell signaling targets from a single sample. Choose from preconfigured kits for maximum convenience in screening routine panels of Th1/Th2 or inflammatory cytokines and chemokines, or build your own multiplex assay using the open and configurable BD CBA Flex Set format.

For all of their power, BD CBA assays are fast and remarkably easy to use. Pre-optimized protocols and one-step detection reagents minimize hands-on time and maximize reproducibility. *(BD Cytometric Bead Array assays are for Research Use Only)*

## Service and Support

**BD Biosciences instruments and reagents are backed by a world-class service and support organization with unmatched flow cytometry experience.**

For over twenty-five years, BD has actively worked with researchers to develop tools that help improve workflow, ease of use, and performance. This in-depth knowledge and experience is available to customers through comprehensive training, application and technical support, and expert field service.

### **Training**

Held at BD training centers worldwide, BD Biosciences flow cytometry training courses combine theory and hands-on practice to provide participants with the skills and experience they need to take full advantage of the capabilities of their instrument.

### **Technical applications support**

BD Biosciences technical applications support specialists are available to provide field- or phone-based assistance and advice. Expert in a diverse array of topics, BD technical application specialists are well equipped to address customer needs in both instrument and applications support.

### **Field service engineers**

BD Biosciences field service engineers are located across the world. When instrument installation or service is required, a BD Biosciences technical field service engineer can be dispatched to your site. On-site service and maintenance agreements are available to provide long-term support.





---

**Regional Offices** [bdbiosciences.com/offices](http://bdbiosciences.com/offices)

**Asia Pacific**  
**BD Singapore**  
Tel 65.6861.0633  
Fax 65.6860.1593

**Australia/New Zealand**  
**Australia**  
Toll Free: 1800 656 100  
Tel 61.2.8875.7000  
Fax 61.2.8875.7200  
[bd\\_anz@bd.com](mailto:bd_anz@bd.com)

**New Zealand**  
Toll Free: 0800 572.468  
Tel 64.9.574.2468  
Fax 64.9.574.2469  
[bd\\_anz@bd.com](mailto:bd_anz@bd.com)

**Europe**  
**BD Biosciences**  
Tel 32.2.400.98.95  
Fax 32.2.401.70.94  
[help.biosciences@europe.bd.com](mailto:help.biosciences@europe.bd.com)

**Canada**  
**BD Biosciences**  
Toll Free 888.259.0187  
Tel 905.542.8028  
Fax 888.229.9918  
[canada@bd.com](mailto:canada@bd.com)

**Japan**  
**Nippon Becton Dickinson**  
Toll Free 0120.8555.90  
Tel 81.24.593.5405  
Fax 81.24.593.5761

**Latin America/Caribbean**  
**BD Biosciences**  
Toll Free 0800.771.7157  
Tel 55.11.5185.9995  
Fax 55.11.5185.9895  
[biosciences.brasil@bd.com](mailto:biosciences.brasil@bd.com)

**United States**  
**BD Biosciences**  
[bdbiosciences.com](http://bdbiosciences.com)  
**Customer/Technical Service**  
Toll Free 877.232.8995  
**Bioimaging Systems**  
Fax 301.340.9775  
**Discovery Labware**  
Fax 978.901.7490  
**Immunocytometry Systems**  
Fax 800.325.9637  
**Pharmingen**  
Fax 800.325.9637

BD flow cytometers are Class I (1) laser products.

© 2009 Becton, Dickinson and Company. All rights reserved. No part of this publication may be reproduced, transmitted, transcribed, stored in retrieval systems, or translated into any language or computer language, in any form or by any means: electronic, mechanical, magnetic, optical, chemical, manual, or otherwise, without prior written permission from BD Biosciences.

Unless otherwise noted, all products are for In Vitro Diagnostic Use.

Purchase does not include or carry any right to resell or transfer this product either as a stand-alone product or as a component of another product. Any use of this product other than the permitted use without the express written authorization of Becton Dickinson and Company is strictly prohibited. Product availability and prices are subject to change without notice.

BD, BD Logo and all other trademarks are property of Becton, Dickinson and Company. © 2009 BD

---

**BD Biosciences**  
2350 Qume Drive  
San Jose, CA 95131  
[bdbiosciences.com](http://bdbiosciences.com)

