

BD FACSCalibur Instructions For Use

IVD For In Vitro Diagnostic Use **CE**

bdbiosciences.com
Part No. 643271 Rev. A
November 2007



BD Biosciences
San Jose, CA 95131-1807
USA
Tel (877) 232-8995
Fax (800) 325-9637
facservice@bd.com

Asia Pacific
Tel (65) 6-861-0633
Fax (65) 6-860-1593

EC REP **BENEX Limited**
Bay K 1 a/d
Shannon Industrial Estate
Shannon, County Clare
Ireland
Tel (353) 61-472920
Fax (353) 61-472546

Brazil
Tel (55) 11-5185-9995
Fax (55) 11-5185-9895

Canada
Toll Free (888) 259-0187
Tel (905) 542-8028
Fax (888) 229-9918
canada@bd.com

Europe
Tel (32) 2 400 98 95
Fax (32) 2 401 70 94
help.biosciences@europe.bd.com

Japan
Nippon Becton Dickinson
Company, Ltd.
Toll Free 0120-8555-90
Tel 81-24-593-5405
Fax 81-24-593-5761

Mexico
Toll Free 01-800-236-2543
Tel (52) 55 5999 8296
Fax (52) 55-5999-8288

© 2007, Becton, Dickinson and Company. All rights reserved. No part of this publication may be reproduced, transmitted, transcribed, stored in retrieval systems, or translated into any language or computer language, in any form or by any means: electronic, mechanical, magnetic, optical, chemical, manual, or otherwise, without prior written permission from BD Biosciences.

The information in this guide is subject to change without notice. BD Biosciences reserves the right to change its products and services at any time to incorporate the latest technological developments. Although this guide has been prepared with every precaution to ensure accuracy, BD Biosciences assumes no liability for any errors or omissions, nor for any damages resulting from the application or use of this information. BD Biosciences welcomes customer input on corrections and suggestions for improvement.

BD FACStation software © 2007, Becton, Dickinson and Company. This software is the property of Becton, Dickinson and Company. Each sale of a stored unit of this software grants the purchaser a nontransferable, nonexclusive, personal license. This software may not be duplicated, reproduced, or copied in any form or by any means whatsoever, except as otherwise permitted by law.

BD FACStation software was written with MacApp®, © Apple®, Inc. The MacApp software is proprietary to Apple, Inc. and is licensed to BD Biosciences for distribution only for use in combination with this software. Apple, Inc. makes no warranties whatsoever, either expressed or implied, regarding this product, including warranties with respect to its merchantability or its fitness for any particular purpose.

Apple, Mac, Macintosh, and Power Macintosh are trademarks of Apple, Inc, registered in the US and other countries. Finder, Power Mac, and QuickTime are trademarks of Apple, Inc.

Microsoft is a registered trademark of Microsoft Corporation.

Clorox is a registered trademark of The Clorox Company.

Coherent is a registered trademark of Coherent, Inc.

JDS Uniphase is a trademark of JDS Uniphase Corporation.

BD, BD Logo and all other trademarks are property of Becton, Dickinson and Company. © 2007 BD

All other company and product names might be trademarks of the respective companies with which they are associated.

Patents

PerCP: US 4,876,190

APC-Cy7: US 5,714,386

FCC Information

WARNING: Changes or modifications to this unit not expressly approved by the party responsible for compliance could void the user's authority to operate the equipment.

NOTICE: This equipment has been tested and found to comply with the limits for a Class A digital device, pursuant to Part 15 of the FCC Rules. These limits are designed to provide reasonable protection against harmful interference when the equipment is operated in a commercial environment. This equipment generates, uses, and can radiate radio frequency energy and, if not installed and used in accordance with the instruction manual, may cause harmful interference to radio communications. Operation of this equipment in a residential area is likely to cause harmful interference in which case the user will be required to correct the interference at his or her own expense.

Shielded cables must be used with this unit to ensure compliance with the Class A FCC limits.

This Class A digital apparatus meets all requirements of the Canadian Interference-Causing Equipment Regulations.

Cet appareil numérique de la classe A respecte toutes les exigences du Règlement sur le matériel brouilleur du Canada.

History

Revision	Date	Change Made
343931 Rev. A	6/05	Initial release
345967 Rev. A	8/05	Changed translation locations on first page of guide.
643271 Rev. A	11/07	Revised for Intel processor details.

Contents

About These Instructions	xi
Conventions	xi
Chapter 1: Introduction	13
System Components and Theory of Operation	14
Cytometer Components	15
Loader (Optional)	20
Power Controls	22
System Requirements	23
Chapter 2: BD FACStation Software	25
BDPAC Software	27
BD CellQuest Pro Software	28
BD CellQuest Pro Files	30
BD FACSComp Software	31
BD FACSComp Preferences	33
BD FACSComp Files	34
BD Multiset Software	39
BD Multiset Preferences	41
BD Multiset Tools	43
BD Multiset Files	45
BD HLA-B27 Software	47
BD HLA-B27 Preferences	49
BD HLA-B27 Files	50

BD FACS Loader Software	51
Worklist Manager Preferences	53
Worklist Manager Files	53
Chapter 3: Starting Up	55
Filling the Sheath Reservoir	56
Priming the Fluidics	58
Emptying the Waste Reservoir	58
Chapter 4: Instrument QC	61
Setting Up for QC	62
Editing Target Values	65
Running BD FACSComp Software	66
Acquiring with the Loader	66
Acquiring Manually	69
Viewing Results	77
Optimizing Settings	79
Downloading Instrument Settings	82
Logging QC Results	83
Chapter 5: Running Samples Manually	85
Running Samples with BD CellQuest Pro Software	86
Setting Up an Experiment Document	86
Optimizing Settings	90
Acquiring Data	99
Analyzing Data	113
Running Samples with BD Multiset Software	121
Setting Up	121
Acquiring Data	130
Reviewing Lab Reports	133
Analyzing Data	137

Running Samples with BD HLA-B27 Software	139
Setting Up	139
Acquiring Data	144
Analyzing Data	146
Chapter 6: Running Samples with the Loader	149
Preparing an Acquisition Document	150
Setting Up BD Worklist Manager Software	151
Setting Up Assay Settings	153
Running BD FACSComp Software	155
Saving the Worklist	155
Entering Sample Information	156
Assigning Racks	158
Running Samples	160
Pausing Acquisition	163
Rerunning a Sample	164
Chapter 7: Shutting Down	165
Daily Shutdown with the Loader	166
Chapter 8: Maintenance	169
Scheduled Maintenance	170
Decontaminating the Fluidics	171
Changing the Sheath Filter	173
Unscheduled Maintenance	175
Changing the Bal Seal	176
Changing the Sample O-ring	178
Loader Maintenance	179
Checking Tube Lifter Calibration	180
Verifying Connection Ports	181
Replacing the Loader Seal	182

Cleaning the Tube Lifter	184
Modifying the Cytometer for Non-Loader Use	186
Chapter 9: Troubleshooting	189
Instrument Troubleshooting	190
Acquisition Troubleshooting	191
BD FACSComp Troubleshooting	195
PMT Adjustment	195
Time Delay Setup	197
Fluorescence Compensation	198
Sensitivity Test	199
HLA-B27 Calibration	199
BD Multiset Troubleshooting	200
Error Codes	200
General BD Multiset Software	201
BD Multiset Results	203
Loader Troubleshooting	208
Worklist Manager Troubleshooting	210
Appendix A: Supplies and Replacement Parts	211
Instrument Supplies	212
Accessory Kit	212
Other Replacement Parts	213
Consumables	214
Instrument Setup	214
Reagents	215
Labware	215

Appendix B: Technical Specifications	217
Cytometer Specifications	218
Environment	219
Performance	219
Optics	220
Fluidics	221
Signal Processing	222
Loader Specifications	222
Connections	223
Appendix C: Performance Data	225
Accuracy	226
Precision	227
Linearity	229
Index	231

About These Instructions





These instructions describe how to operate your BD FACSCalibur™ flow cytometer using BD FACStation™ software. BD Biosciences recommends that first-time users take advantage of operator training offered with the sale of every new instrument.

The *BD FACSCalibur Instructions for Use* assumes you have a working knowledge of the Mac® OS X operating system.

Conventions

The following conventions are used in these instructions.

Table 1 Hazard symbols^a

Symbol	Meaning
	CAUTION: hazard or unsafe practice that could result in material damage, data loss, minor or severe injury, or death
	Electrical danger
	Laser radiation
	Biological risk

a. Although these symbols appear in color on the instrument, they are in black and white throughout this user's guide; their meaning remains unchanged.

Table 2 Text and keyboard conventions

Convention	Use
☑ Tip	Highlights features or hints that can save time and prevent difficulties
<i>Italics</i>	Italics are used to highlight book titles and new or unfamiliar terms on their first appearance in the text.
>	The arrow indicates a menu choice. For example, “choose File > Print” means to choose Print from the File menu.
Command-X	Keyboard shortcuts use the Command key (⌘) in combination with another indicated keystroke. For example, Command-K means to hold down the Command key while pressing the letter <i>k</i> .

Introduction

The BD FACSCalibur flow cytometer identifies and enumerates lymphocyte subsets in human cells in suspension.

System Components and Theory of Operation

The BD FACSCalibur system consists of a flow cytometer and BD FACStation workstation (Figure 1-1). An optional, automated sample loader is also available.

Figure 1-1 BD FACSCalibur system with BD FACS Loader option



Cytometer Components

Figure 1-2 BD FACSCalibur sensor unit

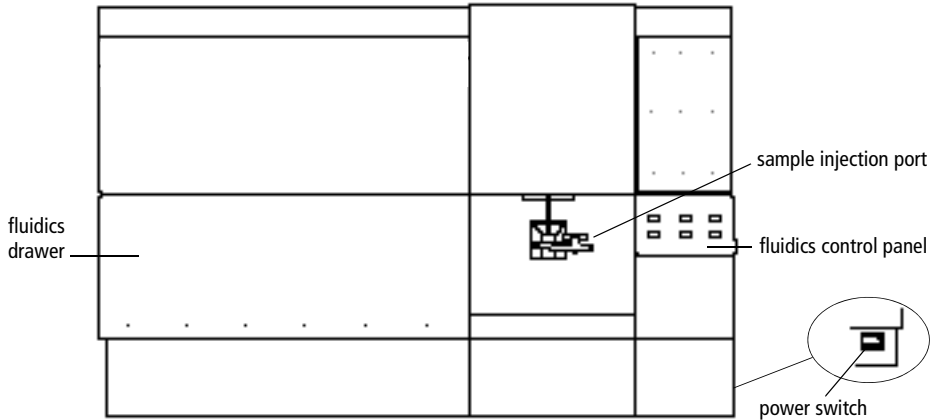

Fluidics Components and Theory of Operation

You install tubes onto the sample injection port (SIP). Samples are carried to the flow cell through a stainless steel sample injection tube (SIT) surrounded by a droplet containment sleeve. The sleeve works in conjunction with a vacuum pump to eliminate droplets as fluid backflows from the SIT. The vacuum pump is activated by the tube support arm—the vacuum is on when the arm is to the side and off when the arm is centered.

Figure 1-3 Sample injection port (SIP)

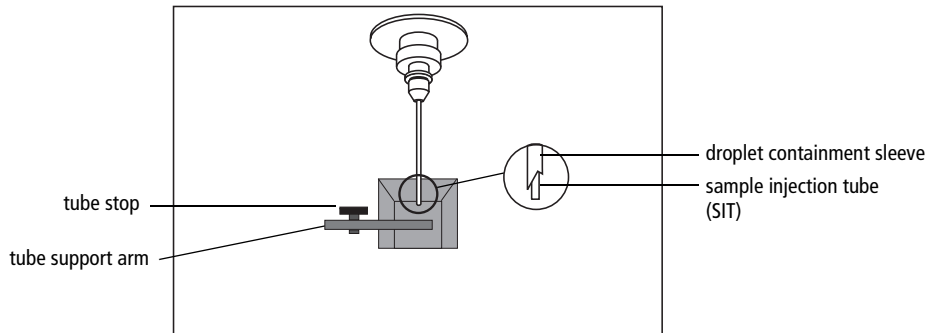

Buttons in the fluidics control panel are used to set the sample flow rate and fluid modes.

Figure 1-4 Fluidics control panel

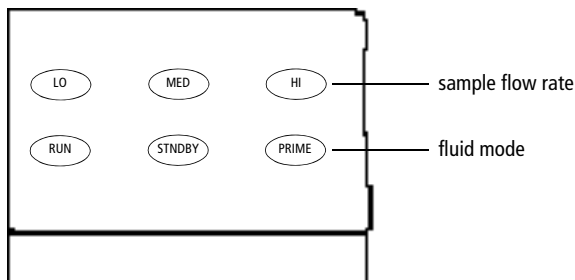

Approximate sample flow rate:

- LO: 12 $\mu\text{L} \pm 3 \mu\text{L}/\text{min}$
- MED: 35 $\mu\text{L} \pm 5 \mu\text{L}/\text{min}$
- HI: 60 $\mu\text{L} \pm 7 \mu\text{L}/\text{min}$

Fluid modes:

- RUN pressurizes the sample tube to transport sample through the SIT and into the flow cell. The button is green when a sample tube is installed, the tube support arm is centered, and the tube is pressurized. When the arm is to the side, the button turns orange and the instrument switches to standby.
- STNDBY (standby) stops sheath flow to conserve fluid and lowers the blue laser power to prolong laser life.
- PRIME removes bubbles from the flow cell primarily during troubleshooting. At completion, the instrument goes into standby mode.

The fluidics drawer holds the sheath and waste reservoirs. Both reservoirs have level sensors that indicate fluid levels via BD CellQuest™ Pro software.

Figure 1-5 Fluidics Drawer

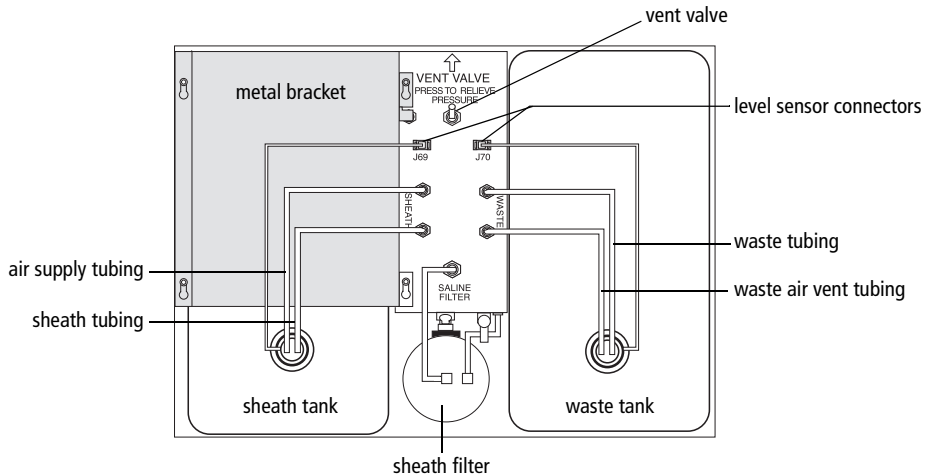

- The 4-L sheath reservoir is secured by a metal bracket, which prevents the reservoir from expanding while under pressure. It holds enough fluid for approximately 3 hours of operation. Fluid is filtered through the sheath filter before it reaches the flow cell.
- The 4-L waste reservoir collects fluid waste from the flow cell.

Optics Components and Theory of Operation

The standard BD FACSCalibur system includes a 15-mW, 488-nm, argon-ion laser and detectors for three fluorescent parameters. The FL4 option provides a second 635-nm, red-diode laser and an additional detector. Laser light is focused onto the flow cell by a focusing lens. As fluorescently tagged particles intercept the laser light in the flow cell, scattered and fluorescent light provide information about particle size, shape, granularity, and fluorescence intensity.

Forward scatter (FSC) signal is collected by the FSC diode. Side scatter (SSC) and fluorescent signals are collected by a fluorescence collection lens and spectrally split by a collection of dichroic mirrors (DMs) and filters. See page 220 for wavelength characteristics of the dichroic mirrors and filters.

Figure 1-6 BD FACSCalibur optics system (standard)

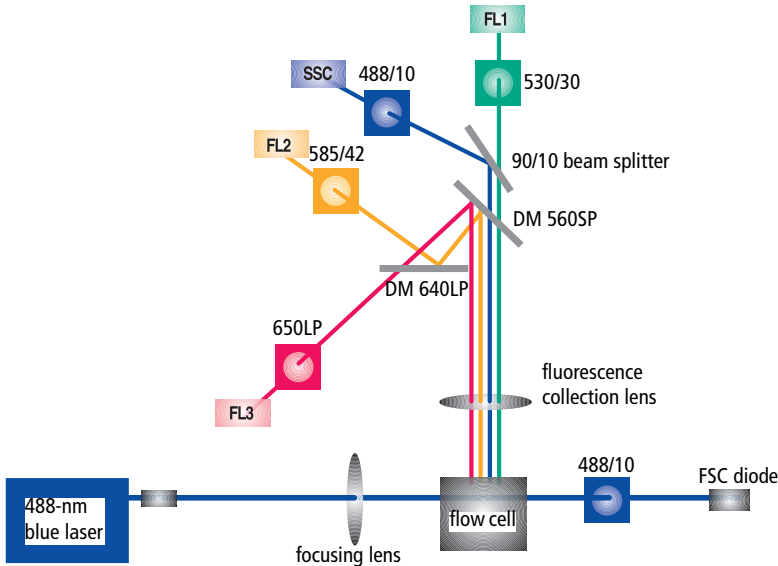
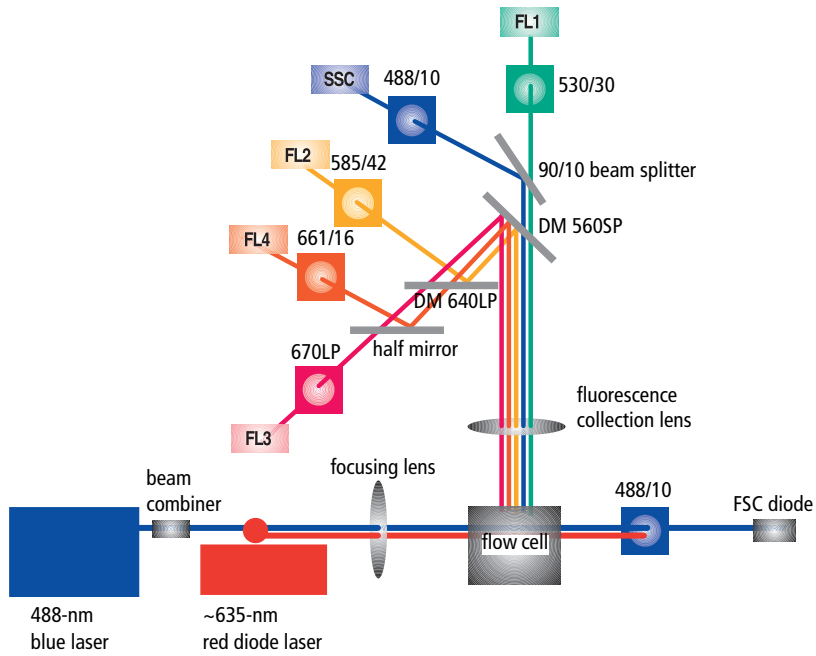

Figure 1-7 Optics system with FL4 option



Loader (Optional)

The BD FACST[™] Loader option automates acquisition from tubes. It mounts directly on the flow cytometer. A cover fits over the drawer to protect you from moving parts.

Figure 1-8 Tube loader components

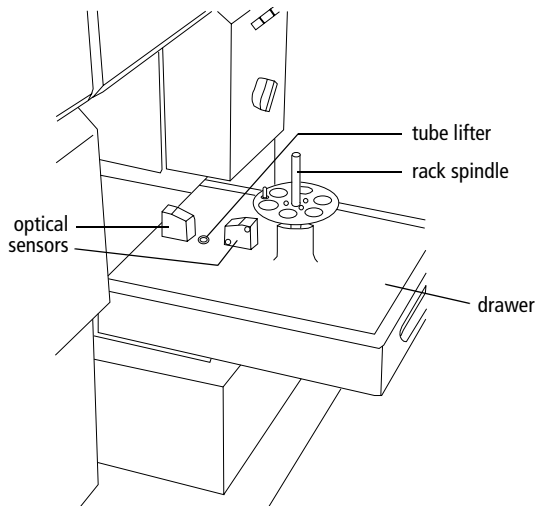

Carousel

The carousel rack accommodates up to forty 12 x 75-mm tubes. Each carousel has a unique ID printed on top and on an optically read label inside.

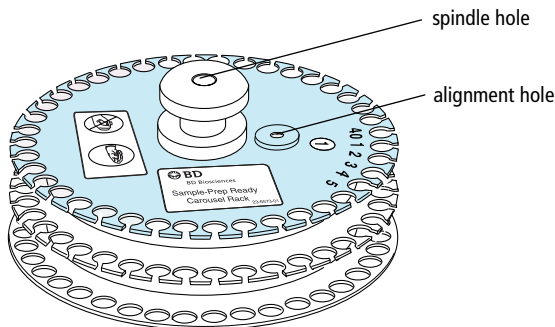

Keypad

The keypad communicates with the Loader via a SCSI cable. Use the keypad to turn the Loader on and off, and to operate it manually. (Keypad keys are disabled during a Worklist run.)

Each time the Loader is turned on and the cover is in place, the Loader performs an initialization scan. The LED display shows Loader status. After a successful scan, the status reads *Tube 01*.

Figure 1-9 Loader keypad

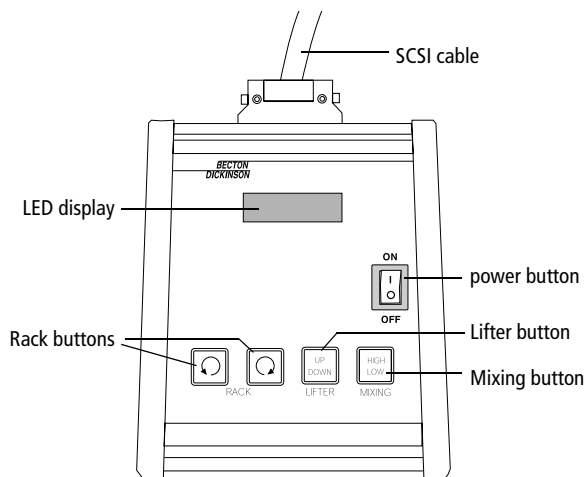

During manual operation, use keypad buttons for the following:

- RACK—moves carousel in the direction indicated
- LIFTER—raises or lowers a tube
- MIXING—vibrates the rack to mix sample tubes
 - Press and release the button for a short (LOW) mix. When finished, the carousel returns to its original position.
 - Press and hold the button for 2 seconds for a longer (HIGH) mix. When finished, the carousel always returns to position 1.

Power Controls

The power switch on the right side of the cytometer does not completely shut off instrument power. To shut off all power, use the switch in back of the instrument (Figure 1-10). If you are using a power transformer, use the main power switch on the transformer (Figure 1-11).

Figure 1-10 Instrument main power switch (115 VAC)

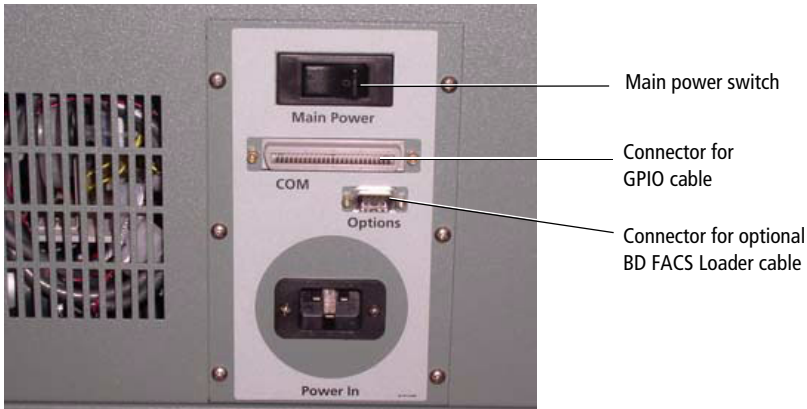
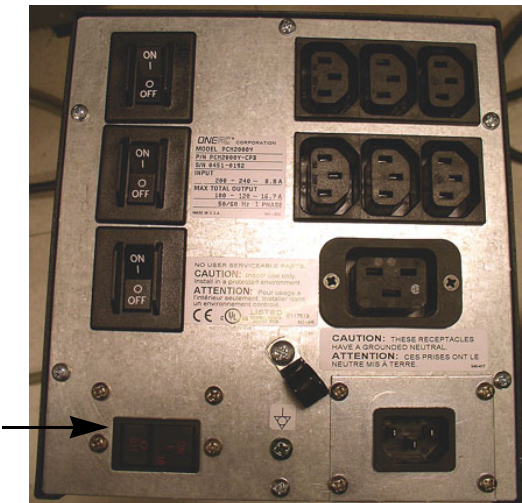

Figure 1-11 Transformer main power switch (230 VAC)



System Requirements

Hardware

- BD FACStation Macintosh® computer purchased through BD Biosciences
- USB security module or dongle (for running BD CellQuest Pro software)
- (optional) BD FACS Loader for automated sample acquisition

Software

- Mac OS X - see the *Read Before You Install* file on the BD FACStation CD for specific version requirements.
- BD FACStation software version 6.0 or later (See Chapter 2 for an overview)

Tubes

- 12 x 75-mm polystyrene BD Falcon™ tubes
- 12 x 75-mm BD Trucount™ tubes

Bulk Fluids

- Sheath: BD FACFlow™ solution
- Cleaning: BD FACSTM Clean or 10% household bleach
- Rinsing: BD FACSTM shutdown solution or deionized (DI) water
- Waste decontamination: full-strength bleach

Setup Beads

BD Calibrite™ beads

2

BD FACStation Software

The following come with the BD FACStation system:



BDPAC software for installing required startup files or BD Inits



BD CellQuest Pro software for general data acquisition and analysis



BD FACSComp™ software for instrument calibration and quality control (instrument settings can also be generated using BD CellQuest Pro or BD Multiset™)



BD™ Worklist Manager and Loader Manager software for operating and maintaining the optional BD FACS Loader

The following can be purchased:



BD Multiset software for identifying lymphocytes and lymphocyte subsets in samples stained with BD Tritest™ and BD Multitest™ reagents, and for acquiring and analyzing samples stained with lyse/wash or lyse/no-wash user-defined reagents (one- through four-color)



BD™ HLA-B27 software for determining HLA-B27 antigen expression

This figure shows the workflow for running samples with BD FACStation software:

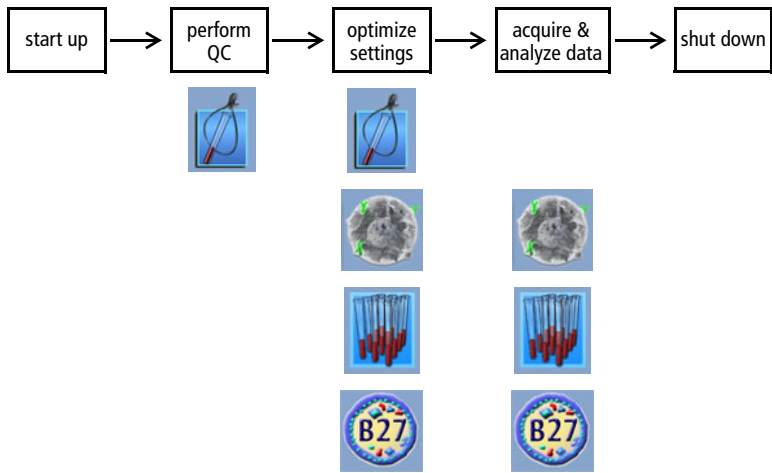

☑ **Tip** To create a shortcut for launching applications, drag the software icon from the Finder window to the Dock. You can then launch the software by clicking its icon in the Dock.



The first time you launch each software application, enter your user name and institution in the Registration dialog:

Registration Information:

User:

Institution:

Quit Save

BDPAC Software

BDPAC software installs required startup files, or BD Inits, needed for acquisition. Update BDPAC information:

- if you reinstall BD FACStation software
 - if you connect your BD FACStation computer to a different cytometer
 - if you upgrade your cytometer with new options
- 1 Quit BD CellQuest Pro software, if it is running.
 - 2 Launch BDPAC software: 
 - 3 Enter the cytometer serial number, and choose the cytometer type.

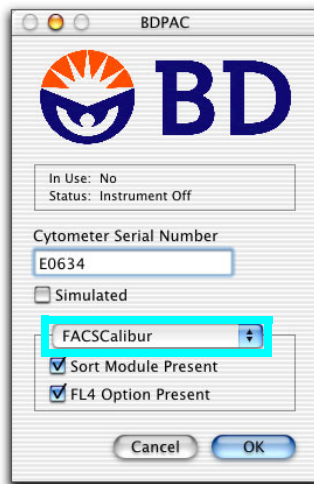





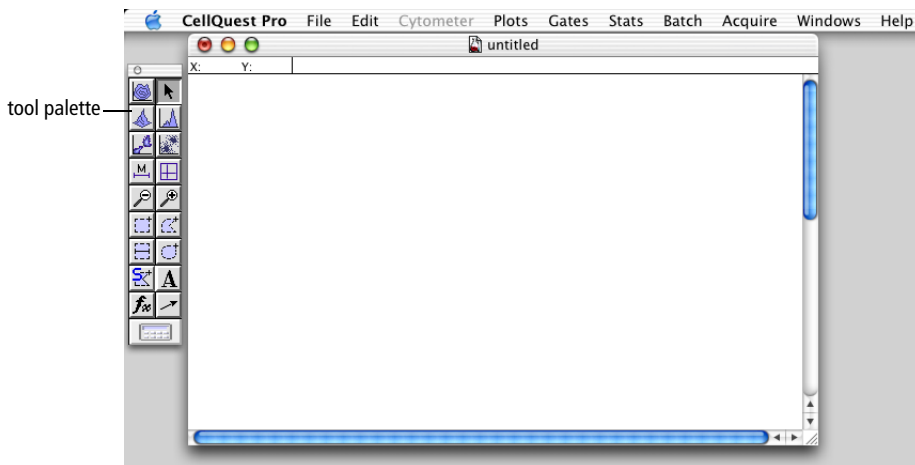

- 4 Select the checkboxes for your cytometer options, and click OK.

BD CellQuest Pro Software

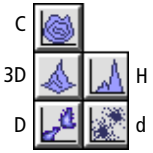

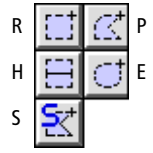

When you launch the software, a blank Experiment document window and the tool palette appear. Use tools in the palette to create or edit objects in the Experiment document window.



	<p>Selection tool—select, move, or resize items in the Experiment document window</p>
	<p>To select an object, click its border: black handles appear. Only selected objects can be deleted, resized, moved, or formatted using the Inspector. (To select more than one object, press Shift as you select.)</p>
	<p>To make an object active, click inside its border: the object's border turns blue. An active object is the target of any chosen commands. Only one object can be active at a time.</p>

	<p>Plot tools—create contour (C), 3-dimensional (3D), density (D), histogram (H), or dot (d) plots</p> <p>To create a plot, select a tool, click in the Experiment document window, and drag to set the plot size.</p>
	<p>Marker tools—select a range of data on a histogram plot (H) or divide a dot, density, or contour plot into quadrants (Q)</p>
	<p>Zoom tools—magnify an area of a plot (+) or return the plot to its original size (-)</p>
	<p>Region tools—create rectangular (R), polygonal (P), elliptical (E), or Snap-To (S) regions on dot, density, or contour plots, or create histogram (H) regions on a histogram plot (histogram regions are used for gates; histogram markers are used for statistics)</p>
	<p>Text tool—create or edit free text</p>
	<p>Arrow tool—draw arrows, starting from an empty area of the Experiment document</p>
	<p>Expression Editor tool—create mathematical expressions using statistical results</p>
	<p>Calculator tool—recalculate data when Auto Recalculate (Gates menu) is turned off</p>

BD CellQuest Pro Files

File Type	Description	Default Name
Experiment document  untitled	BD CellQuest Pro file containing any subset of user-defined plots, regions, gates, markers, statistics, tube lists in Browser, acquisition settings, calculated expressions, text annotations, or color preferences (documents can also be saved as PDFs by choosing File > Print, and clicking Save As PDF)	Untitled n (the software adds a number to each subsequent file)
Data file  Norm.001	FCS 2.0 ^a data file containing parameter measurements for each event in a sample, information about the sample, and cytometer instrument settings in effect when the sample was collected	Data. mmn
Statistics file  untitled stats	Tab-delimited text file containing any combination of histogram, region, gate, and quadrant statistics	untitled stats
Instrument settings file  InstrSettings	BD instrument settings file containing detectors/amps, compensation, and pulse processing (if applicable) settings, threshold parameter and value, and special setup values (if applicable)	InstrSettings

- a. Refer to: Data file standard for flow cytometry. Data File Standards Committee of the International Society for Analytical Cytology. *Cytometry*. 1990;11(3):323-332.



BD FACSCComp Software

Use BD FACSCComp software to monitor instrument performance, and to automatically set up the instrument for two-, three-, and four-color* immunophenotyping of human cells.

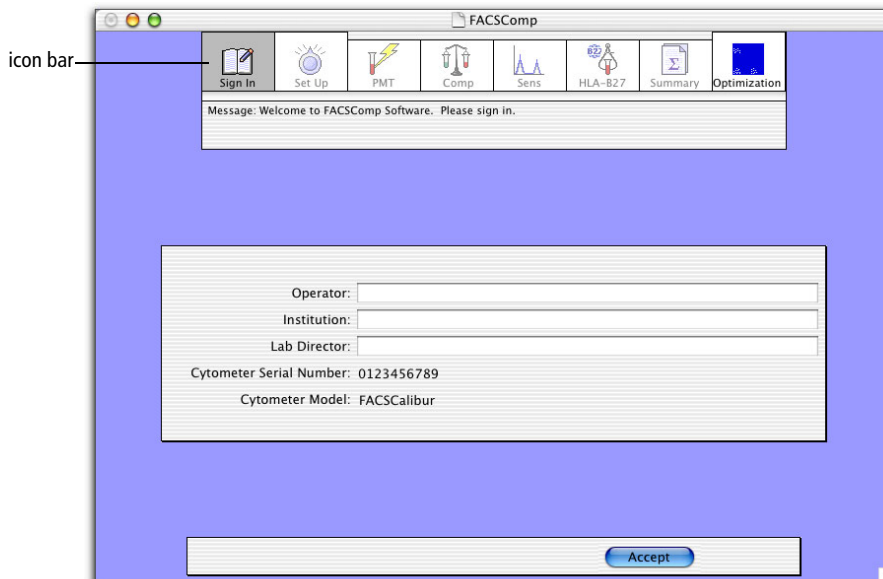





Figure 2-1 BD FACSCComp application window



The icon bar shows where you are in the run—the icon for the current view is highlighted. Do the following at each view.

	Sign in as the operator.
	Select assays to run, enter lot IDs, and specify file names and storage locations.

* FL4 option required for four-color setup.

 <p>PMT</p>	<p>Observe PMT voltage adjustment and time-delay calibration, if APC beads are detected. Adjust voltages manually, if needed.</p>
 <p>Comp</p>	<p>Observe compensation adjustments and adjust compensation manually, if needed.</p>
 <p>Sens</p>	<p>Observe a Sensitivity Test for each parameter.</p>
 <p>HLA-B27</p>	<p>Observe HLA-B27 calibration, when the assay is selected.</p>
 <p>Summary</p>	<p>View or print the status of samples run and files saved.</p>
 <p>Optimization</p>	<p>Check and adjust instrument settings, if necessary, using control samples.</p>

BD FACSComp Preferences

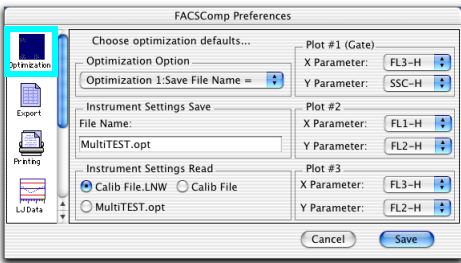
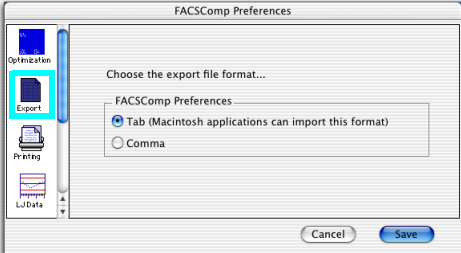
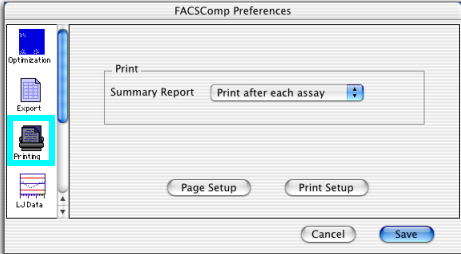
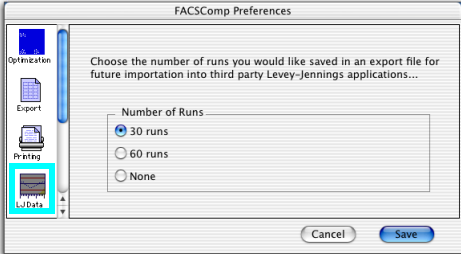
	<p>Use Optimization to change preset choices for an optimization option. The following can be changed:</p> <ul style="list-style-type: none"> • File Name: name of optimized file • Instrument Settings Read: settings to download • Plot X, Y Parameters: choose from drop-down menus
	<p>Use Export to specify delimiter types (Tab or Comma) for exported document files.</p>
	<p>Use Printing to specify when to print Summary Reports: <i>after each assay</i> (automatic printing) or <i>never</i> (you print manually). You can also select to save electronic reports at the Set Up view and print them later.</p> <p>Use Page Setup to set page size and orientation and Print Setup to set printer-specific options.</p>
	<p>Use LJ Data to set the number of BD FACSComp runs to save in each Levey-Jennings file. The file is tab- or comma-delimited depending on your Export preference choice.</p> <p>When the specified number of runs have been saved, new data will replace the oldest entries.</p>

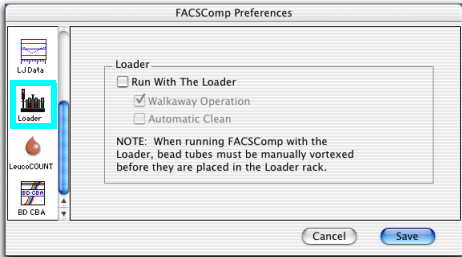
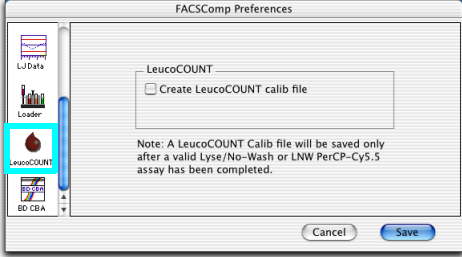





	<p>Use Loader preferences to specify when you will be acquiring data with the Loader. When enabled, you can also select Walkaway Operation to run assays automatically, or Automatic Clean to run cleaning tubes when you quit the software.</p>
	<p>Enable LeucoCOUNT to save a LeucoCOUNT calibration file at the successful completion of any LNW assay. The file is created from modified LNW or LNW PerCP-Cy5.5 settings and is used to set up the cytometer when running BD LeucoCOUNT™-stained samples.</p>









BD FACSComp Files

For LW and LNW assays, BD FACSComp software creates a calibration (calib) file, Target file, and Target Value Log file. You can also choose to save a Summary Report file (at the Set Up view), a Levey-Jennings Database file (in preferences), and an Optimization file (at the Optimization view).

A calib file is created each time BD FACSComp runs to completion. Calib files are BD instrument settings files with a keyword for overall Sensitivity Test results (TRUE if all parameters pass; FALSE if any parameter fails). Only one version of each calib file can exist at a time. Each time a new assay is run, the new file overwrites the previous.

- Tip** To set up for non-IVD applications, refer to the information provided by the manufacturer (reference manual or reagent package insert).

File Type	Description	Default Name	Default Storage Location
LW Calib file 	Instrument settings file with results from LW assay Use to set up cytometer for BD HLA-B27, BD Oncomark™, and BD CellQuest Pro LW applications.	Calib File	BD Files > Instrument Settings Files
LW PerCP-Cy5.5 Calib file 	Instrument settings file with results from LW PerCP-Cy5.5 assay Use for LW applications using PerCP-Cy5.5 reagents.	Calib File. PerCP-Cy5.5	BD Files > Instrument Settings Files
LNW Calib file 	Instrument settings file with results from LNW assay Use for BD Multiset and BD CellQuest Pro LNW applications.	Calib File.LNW	BD Files > Instrument Settings Files
LNW PerCP-Cy5.5 Calib file 	Instrument settings file with results from LNW PerCP-Cy5.5 assay Use for LNW applications using PerCP-Cy5.5 reagents.	Calib File. LNWPerCP-Cy5.5	BD Files > Instrument Settings Files
HLA-B27 Calib file 	Instrument settings file with results from HLA-B27 calibration Use with Calib File to set up for HLA-B27 assays.	Calib File.B27	BD Files > Instrument Settings Files
LeucoCOUNT Calib file 	Instrument settings file with results from LeucoCOUNT calibration (modified LNW settings file) Use to set up for BD Leucocount assays.	LeucoCOUNT Calib File.LNW	BD Files > Instrument Settings Files

File Type	Description	Default Name	Default Storage Location
Target files  Target File  Target File.LNW	<p>BD FACSComp file with target values for BD Calibrite beads. To edit, see page 65.</p> <p>A Target file is also created for HLA-B27. Although used by BD FACSComp software, the file is not editable.</p>	Target File, Target File.LNW	BD Applications > FACSComp Folder
Target value log files  Target Value Log File  Target Value Log File.LNW	<p>BD FACSComp file with operator name, date, and up to 100 sets of target values. Cannot be opened or viewed; only printed from within BD FACSComp software.</p> <p>NOTICE BD FACSComp software does not recognize a Target Value Log file from a previous version. When you upgrade, do not copy your previous Target Value Log file into the FACSComp folder.</p>	Target Value Log File, Target Value Log File.LNW	BD Applications > FACSComp Folder
LW/LNW Summary Reports  170707.sum  170707.sum.pdf	<p>Text (.sum) and graphic (.pdf) files containing analytical results of the run and the resulting instrument settings</p> <p>Two files are produced for each of the LW and LNW assays.</p>	DDMMYY.sum (.pdf), DDMMYY. PerCP-Cy5.5sum (.pdf), DDMMYY.LNW sum(.pdf), DDMMYY.LNW PerCP-Cy5.5sum (.pdf)	BD Files > FACSComp Files >dated folder from day assay was run
HLA-B27 Summary Report  170707.B27sum  170707.B27sum.pdf	<p>Text (.sum) and graphic (.pdf) files showing adjusted FL1 and SSC settings for HLA-B27 testing</p> <p>Two files are produced for each HLA-B27 calibration.</p>	DDMMYY.B27 sum, DDMMYY.B27 sum.pdf	BD Files > FACSComp Files >dated folder from day assay was run





File Type	Description	Default Name	Default Storage Location
Levey Jennings (LJ) Data files  LJ Data  LJ Data, PerCP-Cy5.5  LJ Data, LNW  LJ Data, LNW PerCP-Cy5.5	Text file with Summary Report data from 30 or 60 runs (set in LJ Data preferences). Set the delimiter type in Export preferences (page 33). Open and analyze LJ Data files by third-party programs to monitor instrument performance over time.	LJ Data.LNW LJ Data.LNW PerCP-Cy5.5	BD Applications > FACSComp Folder
 MultiTEST.opt	Optimized instrument settings file	MultiTEST.opt, TriTEST.opt, Simultest.opt	BD Files > Instrument Settings Files

Figure 2-2 Files in BD Applications > FACSComp folder

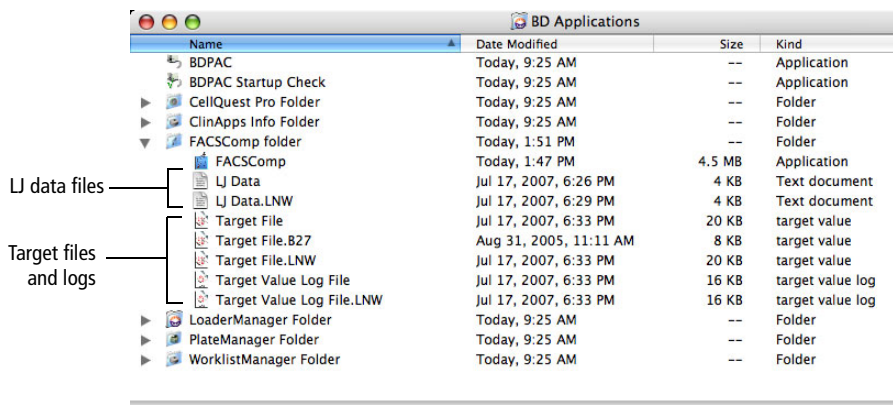

Figure 2-3 Files in BD Files > FACSCComp Files folder

	Name	Date Modified	Size
	▶ CELLQuest Files	August 1, 2007, 5:42 PM	--
	▶ FACSCComp Files	Today, 1:33 PM	--
dated report folder	▶ 170707	Today, 3:36 PM	--
daily summary reports	170707.LNWsum	July 17, 2007, 6:29 PM	4 KB
	170707.LNWsum.pdf	July 17, 2007, 6:29 PM	64 KB
	170707.sum	July 17, 2007, 6:26 PM	4 KB
	170707.sum.pdf	July 17, 2007, 6:26 PM	64 KB
	▶ Instrument Settings Files	Today, 3:37 PM	--
calibration, optimization files	Calib File	October 26, 2006, 5:32 PM	8 KB
	Calib File.B27	October 26, 2006, 5:52 PM	8 KB
	Calib File.LNW	August 2, 2007, 4:31 PM	8 KB
	Calib File.LNWPerCP-Cy5.5	May 16, 2007, 3:40 PM	8 KB
	Calib File.PerCP-Cy5.5	June 19, 2007, 5:21 PM	8 KB
	MultiTEST.opt	May 16, 2007, 3:04 PM	8 KB
	▶ PlateManager Files	Today, 9:25 AM	--
	▶ WorklistManager Files	Today, 9:25 AM	--



BD Multiset Software



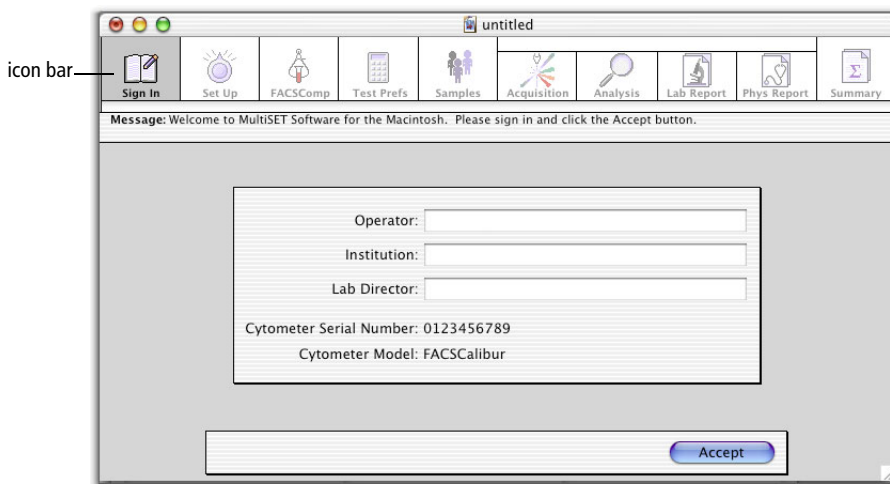

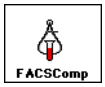

Use BD Multiset software to identify lymphocytes and lymphocyte subsets in samples stained with BD Tritest and BD Multitest reagents, and to acquire and analyze samples stained with lyse/wash or lyse/no-wash user-defined reagents (1- through 4-color).

Figure 2-4 BD Multiset application window



The icon bar shows where you are in the run—the icon for the current view is highlighted. Do the following at each view.

	Sign in as the operator.
	Define run-specific information.
	Launch and run BD FACSComp software.

 <p>Test Prefs</p>	<p>Choose how to report results and which information will appear on reports.</p>
 <p>Samples</p>	<p>Enter sample-specific information.</p>
 <p>Acquisition</p>	<p>Observe data collection in dot plots.</p>
 <p>Analysis</p>	<p>View automatic analysis while in process.</p>
 <p>Lab Report</p>	<p>View or print results for individual sample tubes.</p>
 <p>Phys Report</p>	<p>View or print averaged results for a sample and reference range values.</p>
 <p>Summary</p>	<p>View or print the status of all samples run and files saved.</p>

BD Multiset Preferences

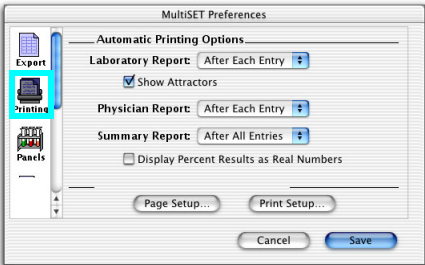
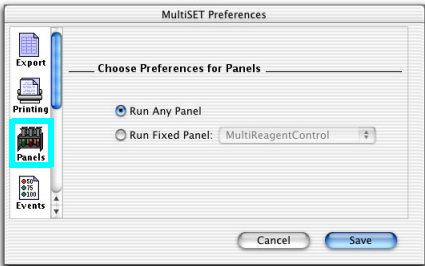
	<p>Use Export to specify delimiter types (Tab or Comma) for exported document files.</p> <p>Click Select Values to Export to choose the values you want included in the export document.</p>
	<p>Use Printing to specify when to print reports: <i>After Each Entry</i> or <i>After All Entries</i> (automatic printing) or <i>Never</i> (you print manually). You can also select to save electronic reports at the Set Up view and print them later.</p> <p>Deselect the Show Attractors checkbox to hide Attractors on Lab Reports; select the Display Percent Results As Real Numbers checkbox if you want percentages shown as real numbers on Summary Reports.</p> <p>Click Page Setup to set page size and orientation and Print Setup to set printer-specific options.</p>
	<p>When the Data Source is From Cytometer, use Panels to choose a default panel (Run Fixed Panel) that will appear at the Samples view for all samples in the run.</p>

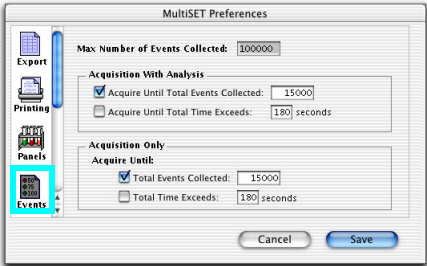
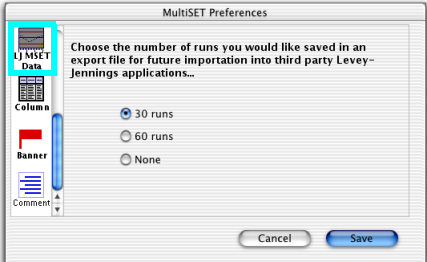
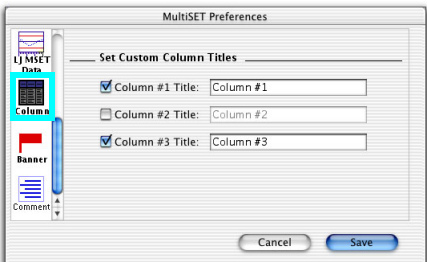
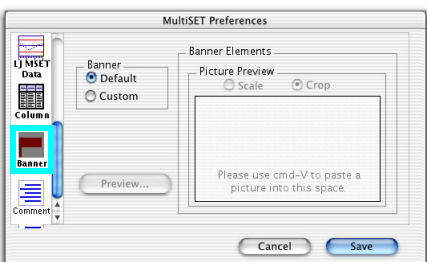
	<p>Use Events to customize acquisition stopping criteria, such as the maximum number of events or maximum acquisition time.</p>
	<p>Use LJ MSET Data to set the number of BD Multiset runs to save in each Levey-Jennings file. The file is tab- or comma-delimited depending on your Export preference choice.</p> <p>When the specified number of runs have been saved, new data will replace the oldest entries.</p>
	<p>Use Columns to display and name up to 3 custom columns in the Samples view.</p> <p>Column information is shown at the Lab Report and Phys Report views, is stored in data files, and can be included in exported documents.</p>
	<p>Use Banner to add a custom banner to the top of reports (eg, your institution's name or logo).</p>

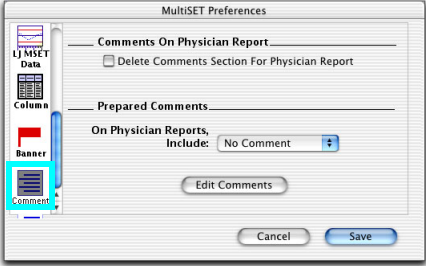

Use **Comments** to define or edit up to 20 comments (Edit Comments), and include a saved comment on Physician Reports.

Alternatively, select to hide the comments section entirely (Delete Comments Section For Physician Report).

BD Multiset Tools

Access the following from the Tools menu.

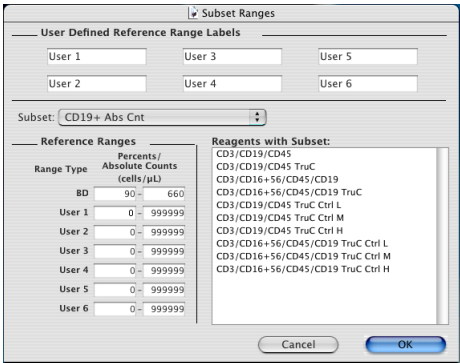

Use **Subset Ranges** to define up to 6 user-defined reference ranges for each subset, in absolute counts, percentages, or ratios.

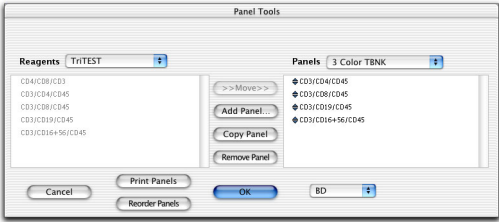

Use **Panel Tools** to create custom reagent panels.

Nine predefined control panels and 4 non-control panels are provided. Use control panels to run BD Trucount Low, Medium, and High Control beads. You cannot create additional control panels.

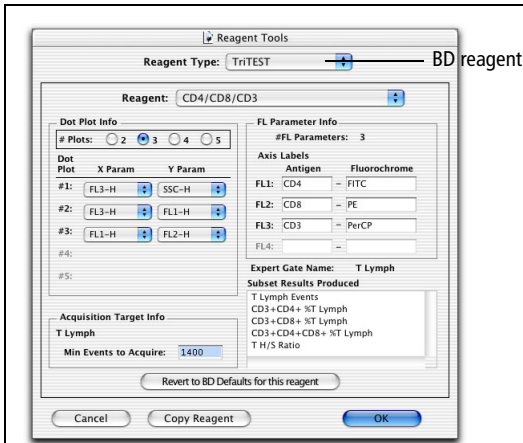

Use **Reagent Tools** to customize Dot Plot Info (number and types of plots associated with each reagent), Acquisition Target Info (minimum number of events to acquire), and FL Parameter Info (antigen or fluorochrome for each parameter) for BD-defined reagents.

Click **Revert to BD Defaults...** to restore the original values. Default values are the BD-preferred values.

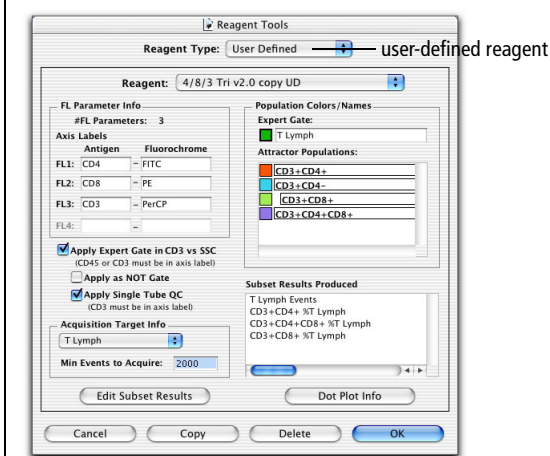

Use **Reagent Tools** to define custom reagents by:

- Copying a BD-defined reagent and customizing FL Parameter Info, Acquisition Target Info, Population Colors/Names, Edit Subset Results, and Dot Plot Info.
- Customizing one of 15 provided Attractor Templates (BD Applications > MultiSET folder > Templates Reagents folder).
- Customizing an Attractor Set created in BD Attractors™ software.

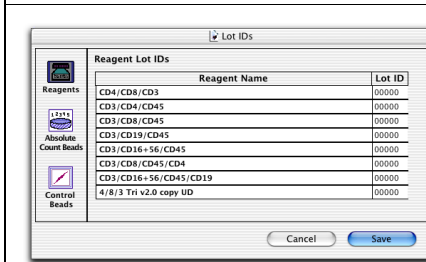







Use **Lot IDs** to enter lot information for reagents, controls, and BD Trucount beads.

Lot information is found in or on the product packaging; enter it manually or use a barcode scanner.

BD Multiset Files

BD Multiset software creates the following file types.

File Type	Description	Default Name	Default Storage Location
Schedule document  <small>010403.sch</small>	BD Multiset file containing entries from Sign In, Set Up, Test Prefs, and Samples views and preferences. Entries in Subset Ranges, Panel Tools, Reagent Tools, and Lot IDs are not saved. ^a	<i>DDMMYY.sch</i>	BD Applications > MultiSET Folder
Lab Report  <small>Alice Wonderland01.lab</small>	PDF file containing individual tube results from one sample with dot plots you choose to include	<i>prefixnm.lab</i> or <i>nnprefix.lab</i> ^b	BD Files > MultiSET Files > dated folder from day assay was run
Physician Report  <small>Alice Wonderland01.phy</small>	PDF file containing panel results from one sample	<i>prefixnm.phy</i> or <i>nnprefix.phy</i> ^b	BD Files > MultiSET Files > dated folder from day assay was run
Summary Report  <small>090403.sum</small>	PDF file listing all samples in the Samples view One Summary Report is saved per Schedule document.	<i>ScheduleDocument Name.sum</i>	BD Files > MultiSET Files > dated folder from day assay was run
Data file  <small>sample 202.01</small>	FCS 2.0 ^c data file containing data for one tube (reagent) of a sample, and cytometer instrument settings in effect when the sample was collected	<i>prefixnm.tube</i> number or <i>nnprefix.tube</i> number ^b	BD Files > MultiSET Files > dated folder from day assay was run

File Type	Description	Default Name	Default Storage Location
Export document 	Text file containing sample and reagent information, and subset results for each tube Export documents can contain data from samples (.exp) or controls (.cxp). The delimiter is set in Export Preferences.	DDMMYY.exp DDMMYY.cxp	BD Files > MultiSET Files > dated folder from day assay was run
Levey-Jennings (LJ) data file 	Text file with control bead data from 30 or 60 runs (set in LJ Data preferences). Set the delimiter type in Export preferences (page 41). Open and analyze LJ Data files by third-party programs to monitor instrument performance over time.	LJ MSET Data	BD Files > MultiSET Files

- a. **NOTICE:** When you open a Schedule document, verify that Subset Ranges, Panel Tools, Reagent Tools, and Lot IDs are correct before you acquire samples. Schedule documents include the latest entries for these settings.
- b. Prefix specified in Set Up view, *m* = entry number at Samples view. Order set in Set Up view.
- c. Refer to: Data file standard for flow cytometry. Data File Standards Committee of the International Society for Analytical Cytology. *Cytometry*. 1990;11(3):323–332.



BD HLA-B27 Software



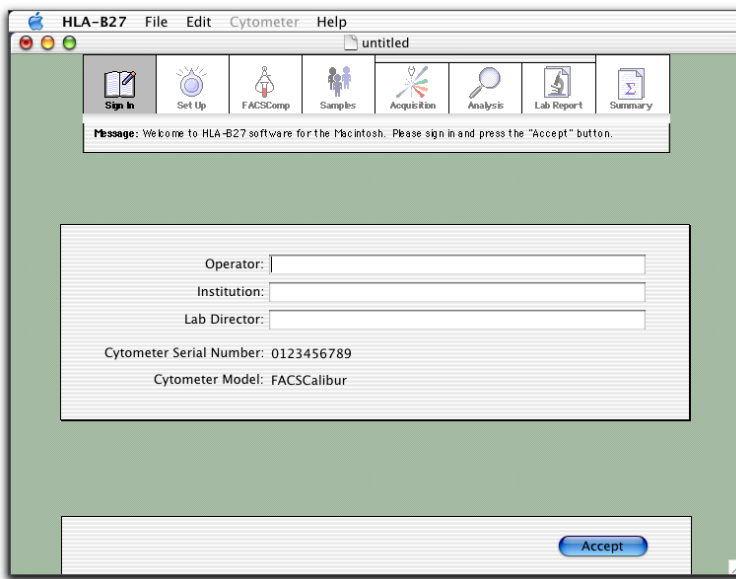



Use BD HLA-B27 software to classify a sample as BD HLA-B27 negative or positive. This classification is based on the measured mean fluorescence intensity (MFI) compared to a predetermined decision-marker setting encoded in the suffix of the reagent antibody lot number.

Figure 2-5 BD HLA-B27 application window



The icon bar shows where you are in the run—the icon for the current view is highlighted. Do the following at each view.

	Sign in as the operator.
	Define run-specific information.



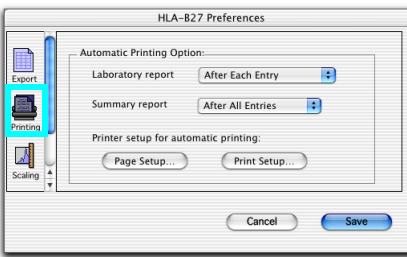
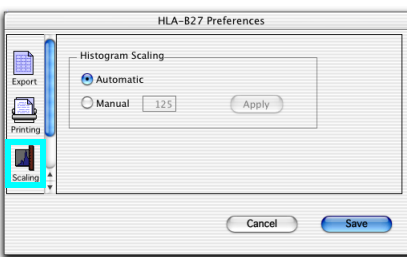
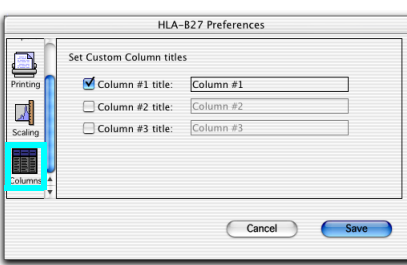

 <p>FACSComp</p>	<p>Launch and run BD FACSCComp software.</p>
 <p>Samples</p>	<p>Enter sample-specific information.</p>
 <p>Acquisition</p>	<p>Observe data collection in dot plots.</p>
 <p>Analysis</p>	<p>View automatic analysis while in process.</p>
 <p>Lab Report</p>	<p>View or print results for individual sample tubes.</p>
 <p>Summary</p>	<p>View or print the status of all samples run and files saved.</p>

BD HLA-B27 Preferences

	<p>Use Export to specify delimiter types (Tab or Comma) for exported document files.</p> <p>Click Select Values to Export to select the values you want included in the exported file.</p>
	<p>Use Printing to specify when to print reports: <i>After Each Entry</i> or <i>After All Entries</i> (automatic printing) or <i>Never</i> (you print manually). You can also select to save electronic reports at the Set Up view and print them later.</p> <p>Use Page Setup to set page size and orientation and Print Setup to set printer-specific options.</p>
	<p>Use Scaling to set default scaling for the histogram in the Lab Report.</p>
	<p>Use Columns to display and name up to 3 custom columns in the Samples view.</p> <p>Column information is shown at the Lab Report and Summary views, is stored in data files, and can be included in exported documents.</p>

BD HLA-B27 Files

BD HLA-B27 software creates the following file types.

File Type	Description	Default Name	Default Storage Location
 <p>042105.sch</p>	<p>Schedule document</p> <p>BD HLA-B27 file containing entries from Sign In, Set Up, and Samples views and preferences.</p>	<i>DDMMYY.sch</i>	BD Applications > HLA-B27 Folder
 <p>Alice Wonderland01.lab</p>	<p>Lab Report</p> <p>PDF file with results from one sample</p>	<i>prefixmm.lab^a</i>	BD Files > HLA-B27 Files > dated folder from day assay was run
 <p>090403.sum</p>	<p>Summary Report</p> <p>PDF file with results from all samples run</p> <p>One Summary Report is saved per Schedule document.</p>	<i>DDMMYY.sum</i>	BD Files > HLA-B27 Files > dated folder from day assay was run
 <p>sample 202.01</p>	<p>Data file</p> <p>BD HLA-B27 FCS 2.0^b data file containing data for one sample, and cytometer instrument settings in effect when the sample was collected</p>	<i>prefixmm.tube number^a</i>	BD Files > HLA-B27 Files > dated folder from day assay was run
 <p>090403.exp</p>	<p>Export document</p> <p>Text file containing values for results you choose to include</p> <p>Values are selected and the delimiter is set in Export Preferences.</p>	<i>DDMMYY.exp</i>	BD Files > HLA-B27 Files > dated folder from day assay was run

- a. Prefix specified in Set Up view, *mm* = entry number at Samples view. If no prefix chosen, file name = *mm*.suffix.
- b. Refer to: Data file standard for flow cytometry. Data File Standards Committee of the International Society for Analytical Cytology. *Cytometry*. 1990;11(3):323–332. **NOTICE:** Only BD HLA-B27 FCS data files can be analyzed by BD HLA-B27 software, including files created by HP HLA-B27 software and translated using BD FACSTM Convert.

BD FACS Loader Software

BD Worklist Manager controls BD acquisition and analysis software (BD CellQuest Pro, BD Multiset, or BD HLA-B27). BD Loader Manager controls Loader hardware. Both interact to control the flow cytometer for automated sample handling.



When Worklist Manager is launched, it automatically launches Loader Manager and verifies the Loader is connected. The Worklist Manager application window and the Loader Manager Status window appear on the desktop.

Figure 2-6 Loader Manager status window

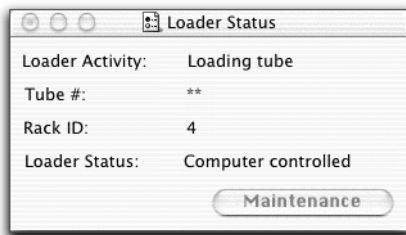
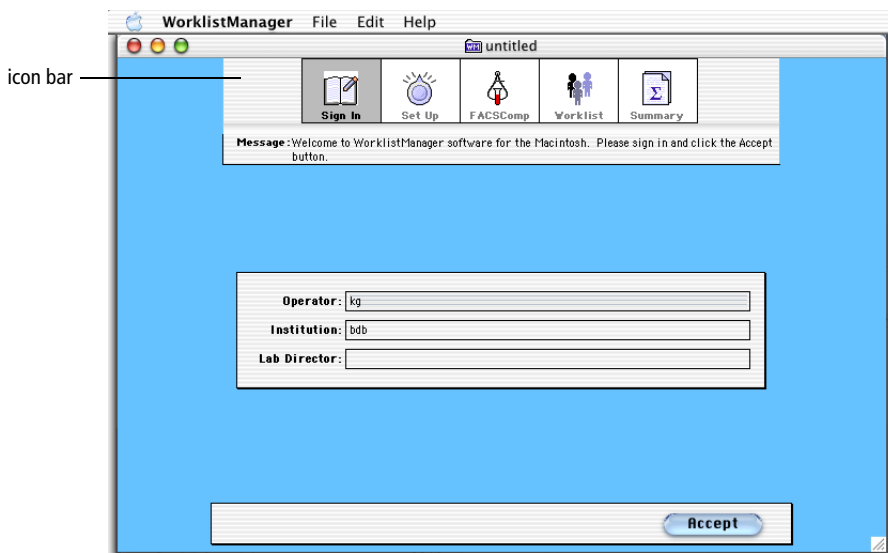







Figure 2-7 Worklist Manager application window



The icon bar shows where you are in the run—the icon for the current view is highlighted. Do the following at each view.

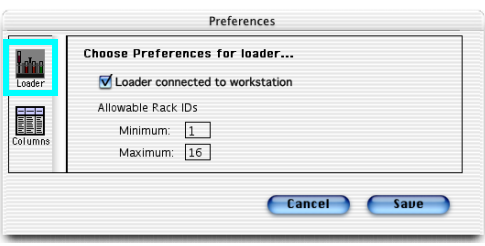
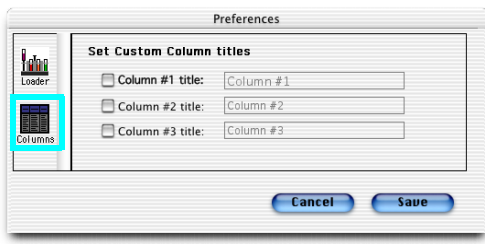

 <p>Sign In</p>	Sign in as the operator.
 <p>Set Up</p>	Define run-specific information.
 <p>FACSCComp</p>	Launch and run BD FACSCComp software.
 <p>Worklist</p>	Identify samples.
 <p>Summary</p>	View or print the status of samples run and files saved.

Worklist Manager Preferences

	<p>Use Loader to disable communication between the Loader and computer workstation, and define allowable rack IDs.</p>
	<p>Use Columns to display and name up to 3 custom columns in the Worklist view. Column information is stored in the text section of FCS data files.</p>

Worklist Manager Files

Worklist Manager can create the following files. (FCS data files are saved by the acquisition software, not by Worklist Manager.)

File Type	Description	Default Name
<p>Worklist document</p>  <p>150403.wrk</p>	<p>All entries from the Sign In, Set Up, and Worklist views, and preference settings</p>	<p><i>DDMMYY.wrk</i> (ie, 150405.wrk)</p>
<p>Summary Report</p>  <p>120503.sum</p>	<p>PDF file containing list of samples run, data files saved, and run status</p>	<p><i>DDMMYY.sum</i> (ie, 150405.sum)</p>

3

Starting Up

1 Turn on the cytometer and the Loader (if applicable).



To ensure proper initialization between the cytometer and the computer, always turn on the cytometer *before* you turn on the computer.

2 Turn on the computer, choose your user ID, and enter your password.

3 Fill the sheath reservoir to 75% capacity (page 56).

4 Empty the waste reservoir (page 58).

5 Check the flow cell for air bubbles.

Tip Use a flashlight for best visibility.

If you see bubbles, prime the fluidics (page 58).



Do not overfill the sheath reservoir. Pressure on an overfull tank can force fluid into the air supply tubing, preventing proper pressurization. Furthermore, because of the additional bleach in the waste reservoir, filling the sheath to maximum capacity can overflow the waste.

9 Replace and tighten the cap assembly.



Make sure the cap is securely tightened and the tubing is not pinched or twisted. If the cap is loose or the tubing is kinked, sample flow could be lessened which will affect your results.

10 Install the reservoir, and replace the metal bracket.

Slide the metal bracket toward you. Make sure the square tab on the right side of the bracket is covering the ball valve.

11 Reconnect the sheath and air supply tubing to their color-coded fittings.

12 Reconnect the level sensor line.

13 Pull the vent valve toward you, and verify the tank is pressurized.

The sheath reservoir should not move under the metal bracket.

14 Check the sheath filter for air bubbles.

If you see bubbles, gently tap the filter body to dislodge bubbles and force them to the top. Push the roller in the pinchcock forward to force the bubbles to waste. Close the pinchcock. Repeat, if necessary.

15 Check the sheath line and the sheath filter line for bubbles.

If bubbles are in either line, disconnect the tubing and press the tip of the connector valve against the side of a waste beaker. Pressurized sheath fluid will force bubbles and sheath fluid out of the tubing.

Priming the Fluidics

Prime the fluidics only to remove bubbles from the flow cell.

- 1 Remove the tube of distilled water from the SIP.
- 2 Press PRIME.

The flow cell drains and fills with sheath fluid. When finished, the STNDBY button turns orange.

- 3 Replace the distilled water tube on the SIP.

Emptying the Waste Reservoir

To prevent the waste reservoir from overflowing, empty it when you fill the sheath reservoir.



All biological specimens and materials coming into contact with them can transmit potentially fatal disease. To prevent exposure to biohazardous agents, expose waste container contents to bleach (10% of total volume) before disposal. Dispose of waste in accordance with local regulations. Use proper precaution and wear suitable protective clothing, eyewear, and gloves.

Figure 3-2 Fluidics drawer

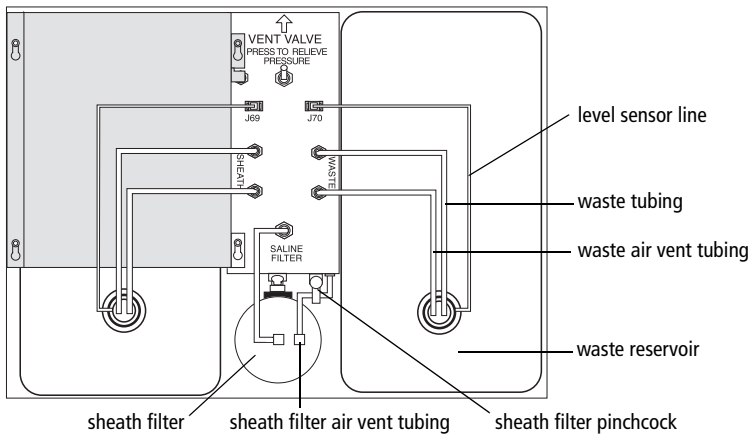

- 1** Slide out the fluidics drawer.
- 2** Disconnect the waste tubing (orange) and the waste air vent tubing (white) from the instrument.
- 3** Disconnect the waste level sensor line.
- 4** Remove the waste reservoir.
- 5** Remove the cap assembly, and empty the bleach-exposed waste.
- 6** Add 400 mL of undiluted bleach to the empty reservoir.
- 7** Replace the cap assembly and hand tighten until it is fully closed.

If necessary, adjust the cap assembly so the tubing is not pinched or twisted and reaches the connectors on the connector panel.
- 8** Reinstall the reservoir.
- 9** Reconnect the waste and air vent tubing to their color-coded fittings.
- 10** Reconnect the waste level sensor line.

Instrument QC

To ensure the flow cytometer provides consistent results, run BD FACSComp software with BD Calibrite beads at the start of each workday. The software adjusts detector voltages to place beads at target channel values and performs a Sensitivity Test to compare signal separation for each parameter to an expected minimum value. Log or export the summary data to track instrument performance over time. For a sample log, see page 83.

NOTICE Because leucocytes have different optical properties than BD Calibrite beads, it is important to optimize settings for cell samples. You can optimize settings in BD FACSComp, BD CellQuest Pro, or BD Multiset software.

This chapter describes how to perform instrument quality control (QC) and optimize settings using BD FACSComp software.

- Setting Up for QC on page 62
- Running BD FACSComp Software on page 66
- Optimizing Settings on page 79
- Logging QC Results on page 83

Setting Up for QC

- 1 Launch BD FACSComp software: 
- 2 At the Sign In view, enter at least the Operator name and click Accept.
Institution and Lab Director are optional.

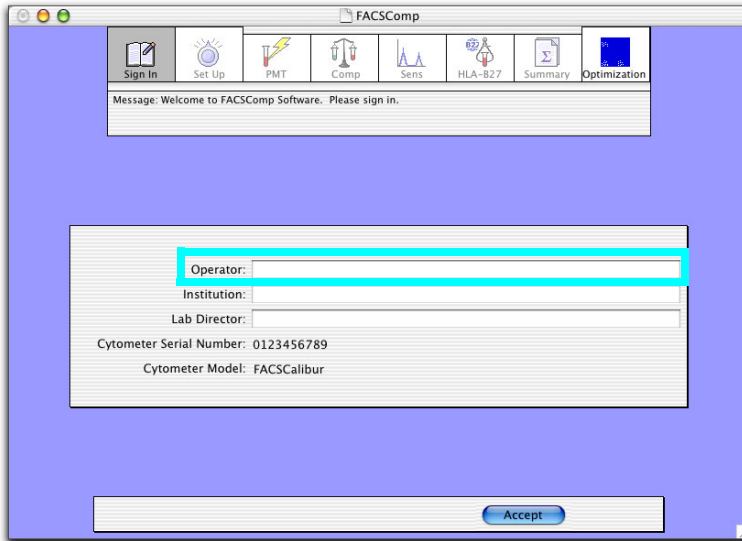

- 3 At the Set Up view under Assay Selection, click the checkbox for each required assay.



Running the wrong BD Calibrite beads for the selected assay will result in inaccurate setup results. Make sure the assay corresponds with the FL3 beads to be run.

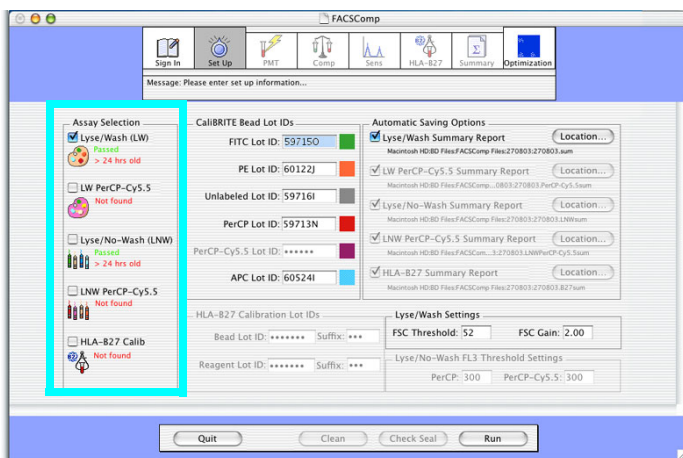

For lyse/wash (LW) or lyse/no-wash (LNW) assays, the software automatically performs 2-, 3-, or 4-color setup based on the BD Calibrite bead lot IDs and the bead populations detected.

- ☑ **Tip** For consistency, run daily QC using the same assay and the maximum number of colors needed. Instrument settings for 4-color LNW are also valid for 3- and 2-color LNW assays, as long as all use the same fluorochromes for FL1, FL2, FL3, and FL4.

NOTICE You must have a valid LW Calib File (*not* Calib File. PerCP-Cy5.5) to perform HLA-B27 calibration.

- 4** Under CaliBRITE Bead Lot IDs, enter the IDs supplied with the current lot of beads.

Enter each ID exactly as shown (five numbers and one capital letter). Do not add a space between the numbers and letter.



Enter the correct lot IDs for the assays to be run. The APC Lot ID is required only for 4-color setup. If APC beads are detected and you do not enter an APC lot ID, 3-color setup will be performed.



For accurate results, make sure target values are appropriate for the current lot of beads. BD Biosciences will notify you when target values need editing because of a change in bead raw material. See page 65.

- 5 Under HLA-B27 Calibration Lot IDs (if appropriate), enter the bead and reagent lot IDs and suffixes.



Make sure the correct information is entered per run. This information is critical for providing accurate results. Only one lot ID can be entered per Schedule document.

NOTICE Rerun HLA-B27 calibration each time you enter new bead lot IDs and suffixes. Information at the Set Up view must correspond to the current HLA-B27 calibration file.

- 6 Under Automatic Saving Options, click the checkbox for each Summary Report you want to save; click the Location button to change the default name or storage location.

A dialog appears where you can enter a new name or different storage location. For file types and default names and locations, see page 34.

- 7 Under Lyse/Wash or Lyse/No-Wash settings, if you know your application's usual threshold value or gain, enter them in the corresponding fields.

The values are not used by BD FACSCComp software, but are saved in the corresponding calibration file. When the settings are downloaded to the cytometer, these values can help facilitate setup.

- 8 Prepare BD Calibrite beads as directed in the reagent insert.

NOTICE For calibrations using PerCP-Cy5.5 beads, dilute beads in Bead Dilution Buffer.

For LW and LNW assays, BD FACSCComp software uses unlabeled beads for automatic PMT adjustment (unlabeled + APC beads for four-color setup), and mixed beads for automatic compensation adjustment and the Sensitivity Test.

Editing Target Values

When BD Calibrite bead raw material changes, BD Biosciences will notify you that you need to input new target values in BD FACSComp software. Do not change the values unless notified.

- 1 Choose FACSComp > Edit Target Values.
- 2 Click OK in the dialog that appears.

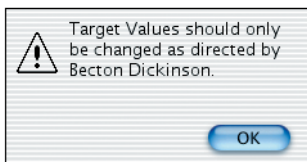

- 3 Enter new Target Values from the insert in the BD Calibrite bead kit.

To view target values for Lyse/No-Wash, select Lyse/No-Wash from the Target File menu. The FL4 target value is from the APC bead lot ID entered at the Set Up view. If no ID has been entered, the value is 0.

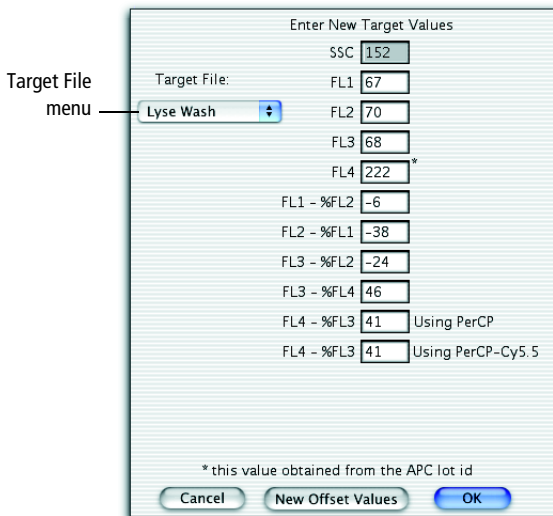

- 4 If new offset values are required, click the New Offset Values button and enter the new values.
- 5 When finished, choose File > Print; repeat for the other target file.
- Tip** Print settings for both LW and LNW target files. Save the printouts for future reference.
- 6 Click OK.

Running BD FACSComp Software

The following section describes how to run with the Loader. To run manually, see page 69.

Acquiring with the Loader

- 1 Choose FACSComp > Preferences and click the Loader icon.
- 2 Select the Run With The Loader checkbox.

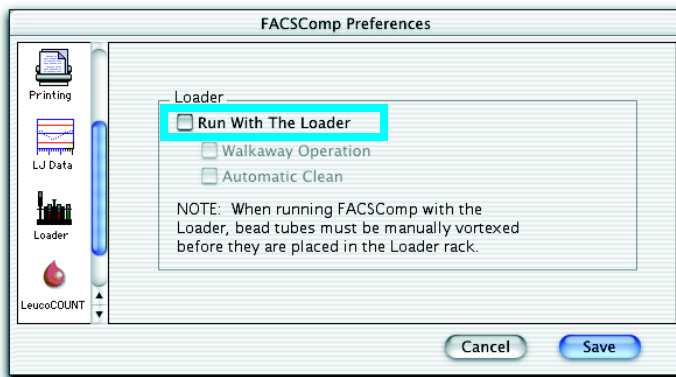

- (Optional) Select Walkaway Operation to run multiple assays automatically.

When the checkbox is deselected, you must click Next Assay at the Summary view to advance to the next tube.

- (Optional) Select Automatic Clean to automatically run a 3-minute clean cycle when you quit the software.

Make sure to install cleaning tubes as shown in Table 4-1. Each tube runs for 1.5 minutes.

- Click Save.
- Gently vortex each tube and place it in its assigned rack position (Table 4-1).

For optimization samples, see page 79.



For accurate results, place each tube only in its assigned rack position. If you are not running an assay, leave the corresponding position empty.

Table 4-1 Tube positions in the Loader rack

Position	Tube
1	unlabeled beads
2	mixed beads for LW and LNW not containing PerCP-Cy5.5
3	mixed beads for LW PerCP-Cy5.5 and LNW PerCP-Cy5.5
4	BD HLA-B27 beads
5–38	optimization samples
39	BD FACS™ Clean solution or 10% bleach solution (3 mL)
40	DI water (3 mL)

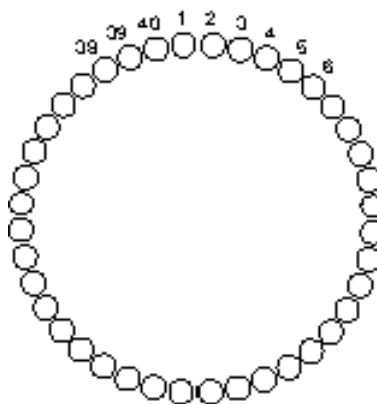

7 Place the rack on the Loader, push in the drawer, and install the cover.

The Loader cycles and *Tube 01* is displayed on the keypad.

8 (Optional) At the Set Up view, click Check Seal or Clean.

- Check Seal raises tube 40 and tests for an adequate seal.
- Clean runs a 3-minute cleaning cycle: tubes 39 and 40 run for 1.5 minutes each.

9 On the cytometer, press RUN and HI.

10 At the Set Up view, click Run.

- During walkaway operation, the Loader automatically lifts appropriate tubes to the SIP and advances through each selected assay. (For a description of each view, see Acquiring Manually on page 69.) When finished, BD FACSCComp software proceeds to the Set Up view.
- During non-walkaway operation, the Loader lifts the first tube to the SIP and runs the corresponding assay. At the Summary view, click Next Assay to advance to the next tube and assay.

NOTICE If an error occurs during walkaway operation, you must acknowledge the error condition before the software will proceed. The tube remains raised until you click OK in the software.



Do not open the Loader cover when the software is running. To access the rack, first click Open Cover in BD FACSCComp software, and open the cover only when the following message appears:

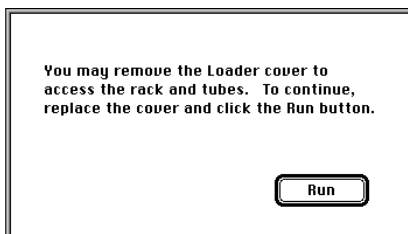

- 11** When the last assay is complete, optimize settings for cell samples if needed (page 79).
- 12** At the Set Up or Summary view, click Quit.

If you selected the Automatic Clean preference, cleaning begins.
- 13** When cleaning is finished, remove the Loader rack, install a tube containing no more than 1 mL of DI water on the SIP, and press STNDBY.

Acquiring Manually

- 1** Gently mix the unlabeled (or unlabeled and APC) bead tube, and install it on the cytometer.
- 2** On the cytometer, press RUN and HI.
- 3** At the Set Up view, click Run; at the PMT view, click Start.

BD FACSCComp software acquires 5,000 events and sets a singlet gate for FSC intensity. After the gate has been set, the software starts automatic PMT voltage adjustments. For instruments with the FL4 option, the software looks for APC beads.

- If no APC beads are found, the second laser is turned off and PMTs are adjusted for 2- or 3-color setup.
- If APC beads are found and an APC bead lot ID was entered at the Set Up view, the second laser remains on, and the FL4 PMT is adjusted.

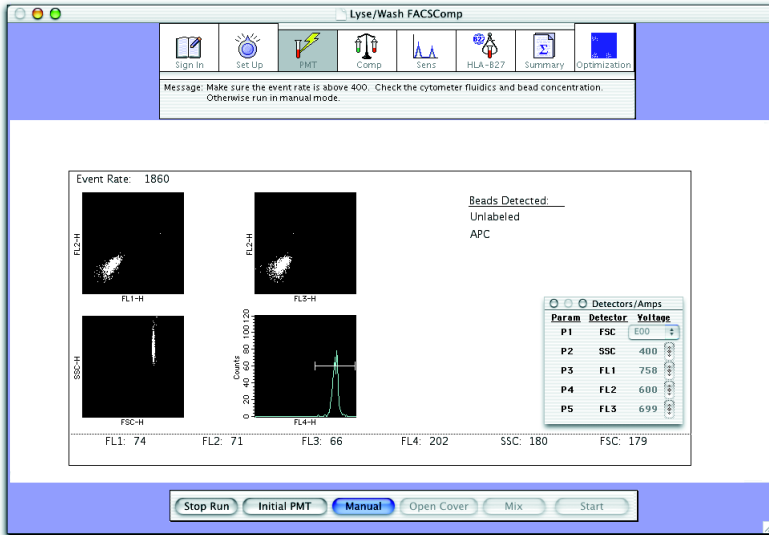

As PMTs are set, checkmarks appear next to the PMT labels below the plots. *PMTs Set Successfully* appears when the values are close to their assigned target.

If PMTs cannot be set automatically, see page 195 for troubleshooting.

The software counts down for 5 seconds. Unless you pause, it proceeds to the Compensation view (3-color compensation), or time-delay calibration (4-color setup).

- If necessary, click Manual to adjust settings manually.

Detectors/Amps controls are enabled and Target Values appear in a separate window. Use the controls to set PMTs to ± 2 channels of the target values for fluorescence PMTs, or ± 5 channels for SSC.

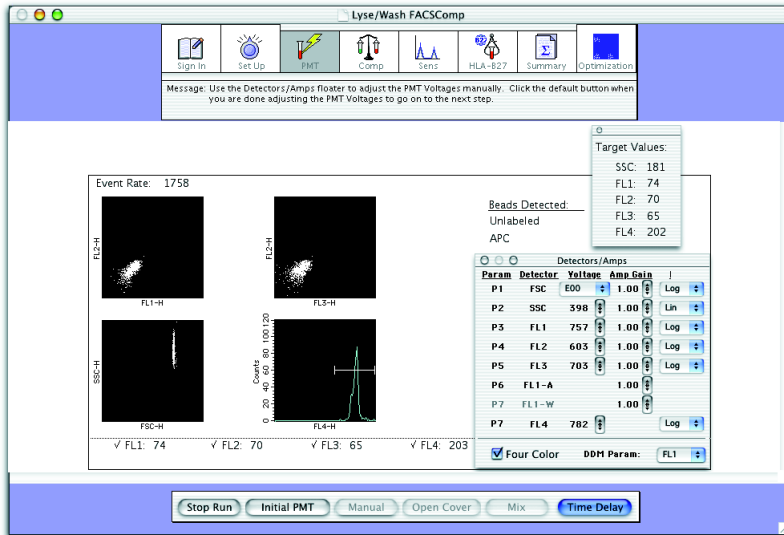

- Click Initial PMT to revert to automatic settings, or
- Click Time Delay or Compensation to save settings and proceed.

Time-Delay Calibration (4-Color Setup)

If APC beads were detected, BD FACSCComp software performs time-delay calibration after the PMTs are set. Leave the unlabeled and APC beads on the cytometer while it is in progress.



If calibration is successful, the following message appears, and the software proceeds to the Compensation view.

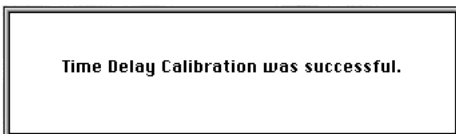

If calibration is not successful, you have 5 seconds to choose from the following:

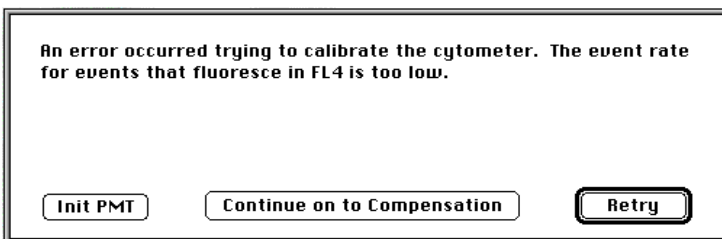

- **Init PMT:** repeat PMT adjustment
- **Continue on to Compensation:** proceed with failed settings
- **Retry:** run time-delay calibration again (See page 197 for troubleshooting.)

If you do not select an option within 5 seconds, the software automatically proceeds to the Compensation view.



If you proceed with compensation after a failed time-delay calibration, the compensation values you obtain for FL3-%FL4 and FL4-%FL3 might vary substantially. If compensation appears incorrect during optimization, verify time-delay calibration. A failed calibration is noted in the comments section of the Summary Report.

Compensation Adjustment

- 1 Remove the unlabeled (or unlabeled and APC) bead tube from the cytometer.
- 2 Gently mix and install the mixed bead tube.



Running the wrong FL3 beads will result in inaccurate FL4-%FL3 results. Make sure to install the appropriate mixed beads tube for the assay.

- 3 At the Comp view, click Start.

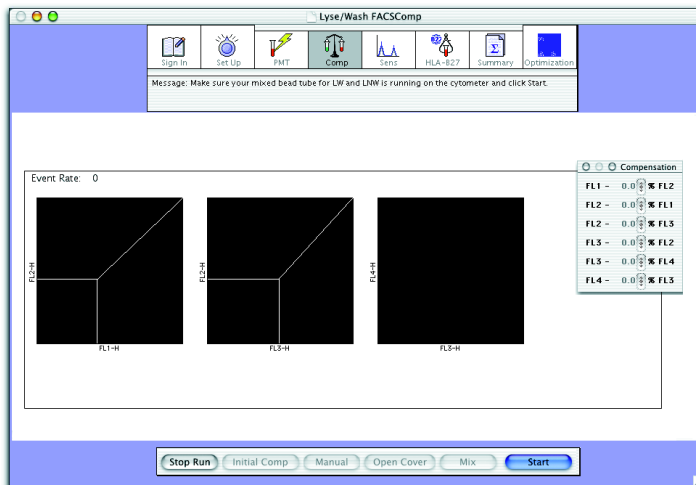

BD FACSComp software adjusts compensation until the target mean difference (or target mean for FL4) is achieved. If APC beads are not detected, 3-color setup is performed. If PerCP beads are not detected, 2-color setup is performed. (You need at least 3 colors to perform PerCP-Cy5.5 assays.)

When compensation is set, checkmarks appear and the message *Compensation Set Successfully* appears. If compensation cannot be set automatically, see page 195 for troubleshooting.

The software counts down for 5 seconds. Unless you pause, it proceeds to the Sensitivity view.

4 If necessary, click **Manual** to adjust compensation manually.

Compensation controls are enabled and Target Values appear in a separate window. Adjust compensation settings until the mean differences below the plots are within ± 2 channels of the target values.

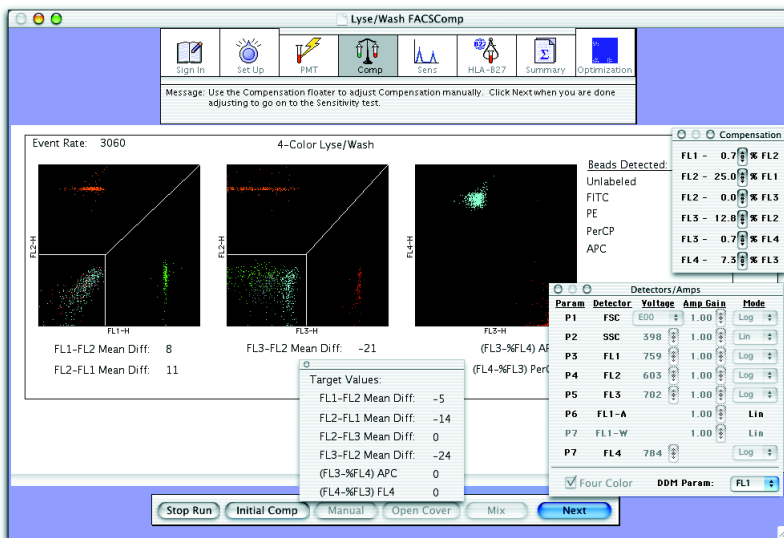

After manual adjustment:

- Click Initial Comp and then Start to revert to the automatic settings, or
- Click Next to save settings and proceed.

Note the following about compensation settings:

- Fluorescence mean channel differences can fluctuate slightly after compensation values are set.
- Bead populations might not be perfectly aligned vertically and horizontally. For example, FL3-%FL2 might appear undercompensated even though its bead positioning is appropriate for placing cell populations in the correct locations.
- Because of different time-delay calibration values, FL3-%FL4 and FL4-%FL3 compensation values can vary considerably from one run to the next. For example, FL4-%FL3 might be 14% for one setup and 7% for the next. Both setups provide compensation values appropriate for your application.

Sensitivity Tests

After compensation is set, the Sensitivity view appears and acquisition of the mixed-bead tube begins automatically.

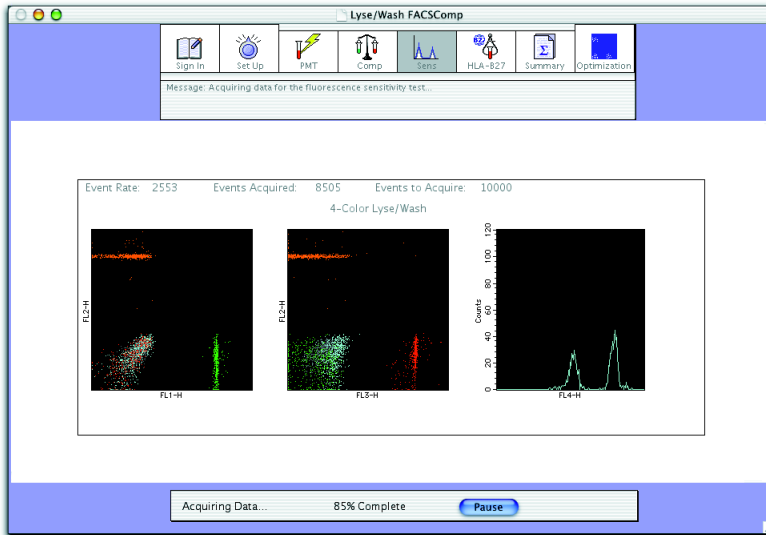

The software automatically proceeds through the following Sensitivity Tests. A minimum separation of signal-to-noise, labeled-to-unlabeled, and APC-to-PerCP (or PerCP-Cy5.5) is encoded in each bead lot ID suffix for a particular parameter. If a parameter's channel separation is greater than or equal to the minimum separation, the parameter passes the Sensitivity Test.

When complete, calibration files are saved in the BD Files > Instrument Settings Files folder.

- Fluorescence Sensitivity Test

The software acquires 10,000 events and calculates fluorescence separation between the means of unlabeled and labeled beads in the FL1, FL2, and FL3 channels. FL4 sensitivity is measured by calculating the separation between the means of the PerCP (or PerCP-Cy5.5) and APC bead signals in the FL4 channel.

- Side Scatter Sensitivity Test

The cytometer produces an electronic test pulse in the FSC parameter. BD FACSComp software acquires 10,000 events, locates the upper test pulse peak channel, then acquires data for the side scatter Sensitivity Test. The separation between noise and the side scatter signal of the beads is calculated. When complete, test pulses are automatically turned off.

- Forward Scatter Sensitivity Test

The software searches for the upper level of FSC noise by lowering the FSC threshold. After it finds the noise level, the software sets the threshold, acquires 10,000 events, and calculates the separation between the threshold and the FSC mean channel of the beads.

Viewing Results

After the Sensitivity Test, a Summary Report is displayed in a scrollable window.

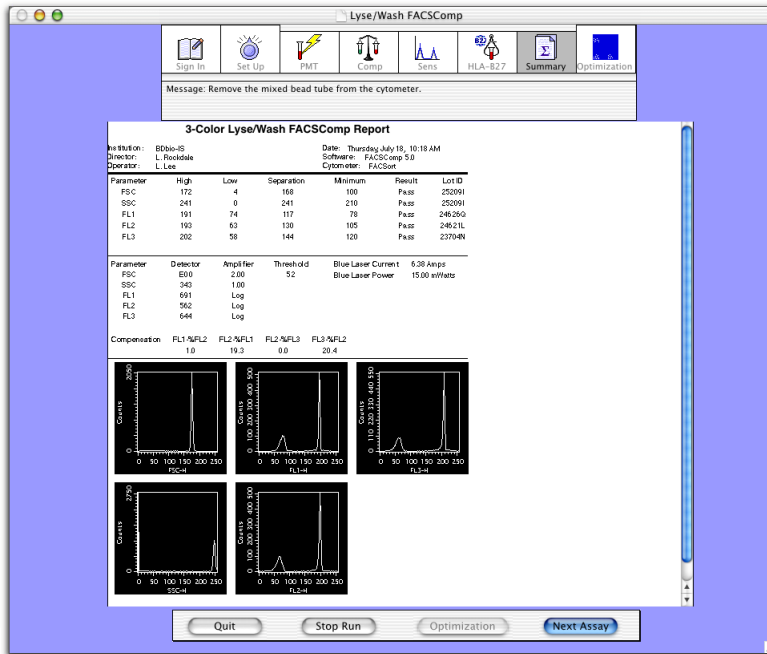

The Summary Report shows histograms and the separations for each parameter, current instrument settings, time-delay calibration results for 4-color setup, and Sensitivity Test results. Two files are saved if specified at the Set Up view: a text file (without graphics) and a PDF file (image of the report). Both files can be opened and printed using standard Macintosh applications.

- 1 Remove the mixed-bead tube and press STNDBY.
- 2 Review the report and enter comments, if needed.

If any parameter failed, see page 199 for troubleshooting.

To enter comments, scroll to the Comments section, click to insert the cursor, and type. If you exceed three lines, text flows to a new page.

NOTICE Comments can be entered only before the file is saved. You cannot add comments after you leave the Summary view.

- 3 Choose File > Print, if needed.

If you selected automatic printing in print preferences, the report will print when you leave the view.

- 4 Select from the following.

- Click Next Assay to proceed with the next assay.

If this was the last assay, click Set Up to return to the Set Up view.

- Click Optimization (enabled after the last assay) to optimize settings. See page 79.
- Click Quit to quit the software.

Optimizing Settings

Because leucocytes have different optical properties than BD Calibrite beads, it is important to optimize instrument settings for cell samples. Optimize settings for 2-color setup using a blood sample stained with any combination of reagents that identifies separate non-overlapping cell populations and stains brightly, such as FITC- and PE-labeled monoclonal antibodies. Optimization following 3- and 4-color setup varies depending on the application. Refer to the appropriate application note or reagent package insert for examples.

This section describes how to optimize settings in BD FACSCComp software. For optimization in BD CellQuest Pro software, see Chapter 5.

- 1** Prepare optimization samples.

For the Loader, place tubes in rack positions 5–38.

- 2** Click Optimization at the Summary view or click the icon in the icon bar.

The Optimization icon is available after the last assay in the run.

- 3** Choose an option from the optimization menu (Figure 4-1).

Plot parameters change for the chosen option, and associated instrument settings are downloaded to the cytometer. Preset options are as follows:

Option	Instrument Settings File Name	Plot 1 Parameters	Plot 2 Parameters	Plot 3 Parameters
1	MultiTEST.opt	FL3 vs SSC	FL1 vs FL2	FL3 vs FL4
2	TriTEST.opt	FL3 vs SSC	FL1 vs FL2	FL3 vs FL2
3	Simultest.opt	FSC vs SSC	FL1 vs FL2	FSC vs SSC

- Tip** Use BD FACSCComp preferences to change default options (page 33). You can also change plot parameters by clicking an axis label and choosing a new parameter, or download a different instrument settings file (page 82).

Figure 4-1 Optimization view



4 Install the control sample on the SIP.

For the Loader, choose the appropriate tube from the tube menu.

5 Click Start.

6 Adjust settings, if needed.

7 (Optional) Set a gate in the first plot, if appropriate.

The other plots will then contain gated data.

- Click Live Gate.
- Move the cursor to the plot and click to set each point.
- Click at the original point to close the gate.
- To redraw, click Live Gate and repeat.

8 Click Save Optimized Settings.

If a file with the same name exists, the following dialog appears:



- Click Rename to save the file with a new name.
- Click Overwrite to use the most recent optimized settings.

By default, settings are saved in BD Files > Instrument Settings Files.

9 At the Optimization view, click Quit.

Downloading Instrument Settings

Do the following to download different instrument settings for optimization.

- 1 Choose Cytometer > Instrument Settings. Click Open.

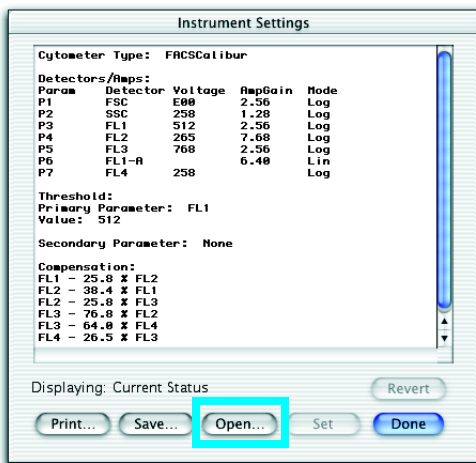

- 2 Navigate to the required instrument settings file (BD Files > Instrument Settings Files), and double-click the file icon.

Tip Any FCS file can be used as an instrument settings file.

The settings change in the Instrument Settings window.

- 3 Click Set.

NOTICE You must click Set to download new settings; otherwise, previous settings apply.

To cancel, click Revert.

- 4 Click Done.

Logging QC Results

To maintain a log of QC results:

- Print the Summary Report.
- Save an electronic file of the Summary Report.
- Copy results from the Summary Report to a QC log such as the following example.
- Save Summary Report results to a file that can be exported to a third-party Levey-Jennings application.

To do so, enable the LJ Data preference (page 33). At the Set Up view, select the Summary Report checkbox for the data you want to save. Data for each Summary Report is saved in a separate file—LJ Data (LW assays), LJ Data.PerCP-Cy5.5 (LW PerCP-Cy5.5 assays), LJ Data.LNW (LNW assays), and LJ Data.LNWPerCP-Cy5.5 (LNW PerCP-Cy5.5 assays).

5

Running Samples Manually

This section describes how to acquire and analyze sample data. For automatic tube loading with the Loader, see Chapter 6.

Before you begin, start up the cytometer (page 55) and perform instrument QC (page 61).

- Running Samples with BD CellQuest Pro Software on page 86
- Running Samples with BD Multiset Software on page 121
- Running Samples with BD HLA-B27 Software on page 139

Running Samples with BD CellQuest Pro Software

This section describes how to optimize settings and acquire and analyze data using BD CellQuest Pro software. As an example, data will be acquired and analyzed for a peripheral blood sample stained with 3- or 4-color reagents. For other analysis methods, refer to the information provided by the reagent manufacturer.

Setting Up an Experiment Document

The Standard Acquisition Experiment document can be used or adapted to optimize instrument settings for your sample. For example, this section shows how to add a plot for 4-color optimization. The document is set up as a stationery pad, so that each time you open it, you create a copy of the original.

- 1 In the Finder window, navigate to BD Applications > CellQuest Pro Folder > Sample Files, and double-click the Standard Acq Experiment document.

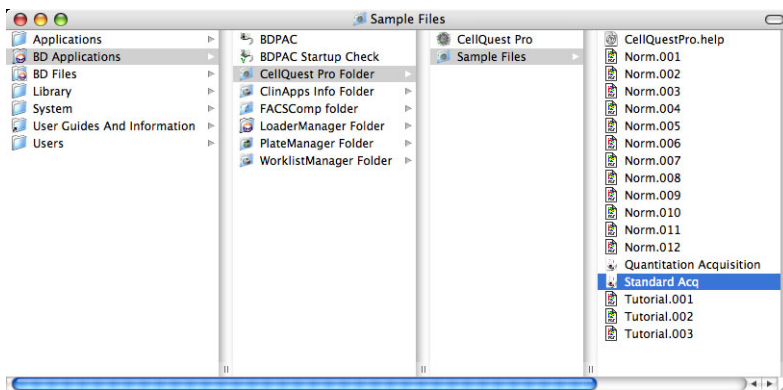

BD CellQuest Pro software launches. The Experiment document window shows the Standard Acquisition document (four plots and statistics views).

- 2 Choose Acquire > Connect to Cytometer (⌘-B).

The Acquisition Control dialog and Acquisition Browser appear.

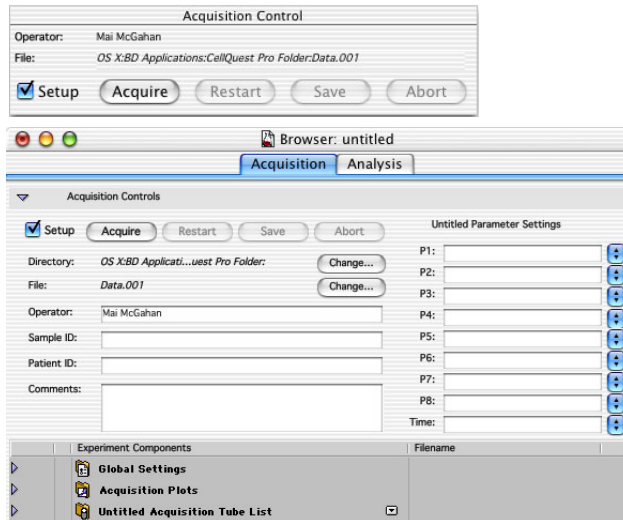

- ✓ **Tip** When you click the Experiment document window, the Browser window moves to the back. To view a hidden Browser window, choose Windows > Browser:*Title X* (where *Title X* is the name of the Experiment document).

- 3 Choose Cytometer > Detectors/Amps, and drag the Detectors/Amps window to the side.

To access instrument controls, you must be connected to the cytometer.

- 4 Choose Cytometer > Threshold, and drag the Threshold window to the side.

- 5 For 4-color experiments, add an FL3 vs FL4 plot to the document.

Select the Dot Plot tool () , click in the Experiment document window, and drag to set the plot size. Along with the plot, the Inspector appears:

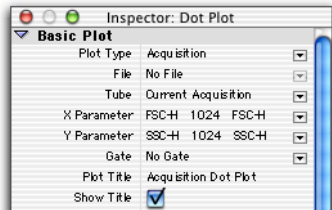

The contents of the Inspector change, depending on the object(s) selected. In this case, the Inspector shows dot plot options.

- 6 In the Inspector window, make sure the Plot Type is Acquisition.

Plots can be Acquisition, Analysis, or Acquisition-to-Analysis.

- Acquisition plots can be histograms, dot plots, or density plots. These plots are used to display live data while optimizing instrument electronics and to define the conditions for data collection and storage.
- Analysis plots can be histograms, dot, density, contour, or 3D plots. These plots are used to display saved data files. Data can be analyzed by creating regions, setting markers, and generating statistics.
- Acquisition-to-analysis plots can be histograms, dot plots, or density plots. These plots change from an acquisition plot to an analysis plot after data acquisition is complete. The data from the file just acquired appear in the plot with any formatting defined during acquisition, for example, regions, markers, or colors.

Restoring Calib Settings

Use BD FACSCComp calibration files as a starting point to optimize settings in BD CellQuest Pro software.

- 1 Choose Cytometer > Instrument Settings. Click Open.

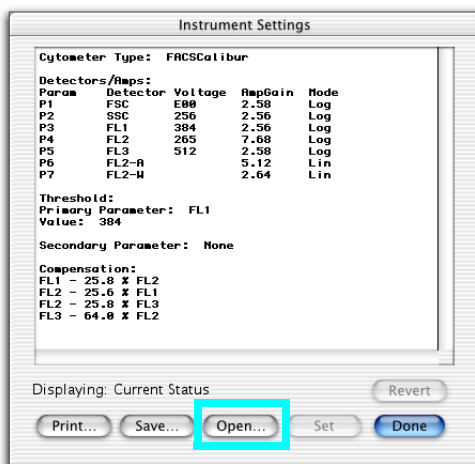

- 2 Navigate to BD Files > Instrument Settings Files, and double-click the Calib File icon.

The settings change in the Instrument Settings window.

- 3 Click Set.

NOTICE You must click Set to download new settings; otherwise, previous settings apply.

To cancel, click Revert.

- 4 Click Done.

Optimizing Settings

Before data is collected, optimize instrument settings as follows:

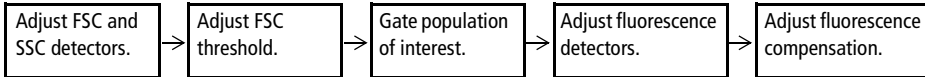

The following control samples are recommended for 4-color optimization:

- isotype control
- compensation controls for each fluorophore in the assay (ie, FITC, PE, PerCP, and APC controls)

Adjusting FSC, SSC, and FSC Threshold

Adjust the FSC Amp Gain and SSC Voltage to appropriately display the scatter properties of the sample and place the population of interest (eg, lymphocytes) on scale. Adjust the FSC Threshold to exclude unwanted debris.

For example, the following plots show cells before and after optimization of FSC and SSC settings. Usually, Calib File settings need minimal adjustment to place lymphocytes on scale.

Figure 5-1 FSC/SSC optimization

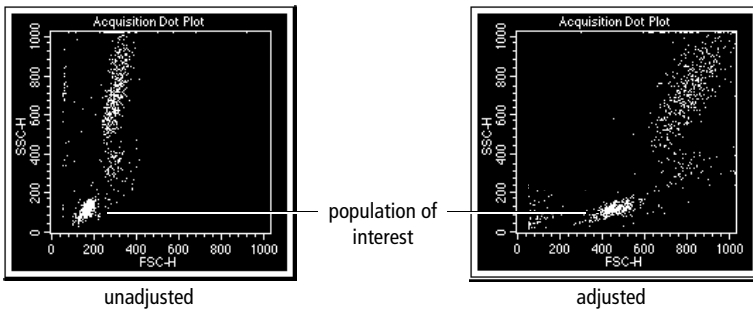

Tip To quickly update the display during optimization, click Pause and then Restart in Acquisition Controls.

- 1 Install the isotype control tube on the SIP.
- 2 Press RUN and the appropriate flow rate button.

Tip Use MED to conserve sample.

- 3 Ensure the Acquisition Control Setup checkbox is checked, and click Acquire.



When Setup is checked, events are shown in plots but not saved.

- 4 Adjust the FSC Amp Gain, and then the SSC Voltage to place the population of interest on scale in the FSC vs SSC plot (Figure 5-1).

Use controls in the Detectors/Amps window to change the setting. If the Amp Gain is unavailable, change the Mode to linear (Lin).



- Click the up or down arrow to change the Amp Gain value by .01.
- Press the Option key and click the arrow to change the value by 0.1.
- To change the value in larger increments, click between the arrows and drag the slider control.

5 In the Threshold window, select FSC-H as the primary parameter.

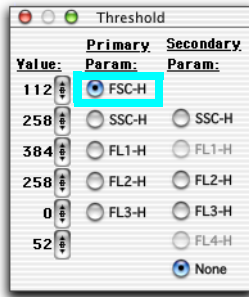

6 Adjust the FSC Threshold Value to remove most of the debris without cutting off the lymphocytes.

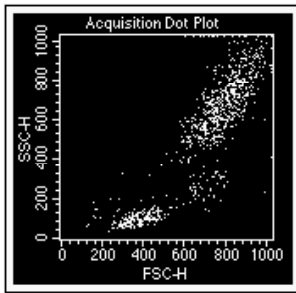

7 Click Pause, and then Abort in Acquisition Controls.

8 (Optional) Remove the isotype control tube from the SIP.

Tip Remove the tube to conserve sample.

Gating the Population of Interest

Cell populations in a sample can have different light scatter and autofluorescent properties. By gating the population of interest, fluorescence detector settings will account for the autofluorescence and nonspecific binding of these cells.

- 1 Create a polygon region around the lymphocyte population in the FSC vs SSC plot.
 - Select the Polygon-Region tool (.
 - Click around the population of interest until the region is complete.
 - Close the region by double-clicking the last vertex or clicking the first.

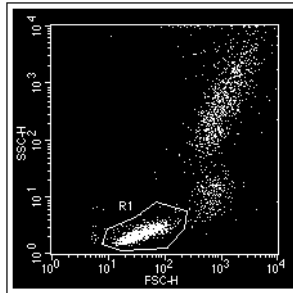

- Tip** To prevent data from being obscured by the region label, click outside the region to deselect it and then drag the label outside the region.

- 2 (Optional) Change the color of the gated population.

Choose Gates > Gate List, and select the Multicolor checkbox. The gated events change to the color shown in the Color box. To change the color, click the Color box and choose a new color.

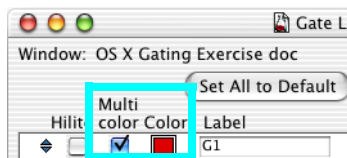

- 3 Select all plots except the FSC vs SSC plot and choose Windows > Show Inspector.

To select multiple plots, press Shift as you click the border of each plot. A selected object has selection handles on each corner.

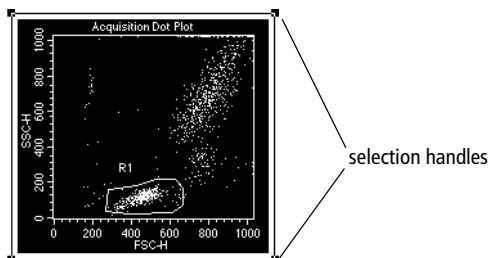

The contents of the Inspector change, depending on the object(s) selected. In this case, the Inspector shows dot plot options.

- 4 Choose G1 = R1 from the Gate pop-up menu.

The plots change to show only events that are in gate G1 (lymphocytes).

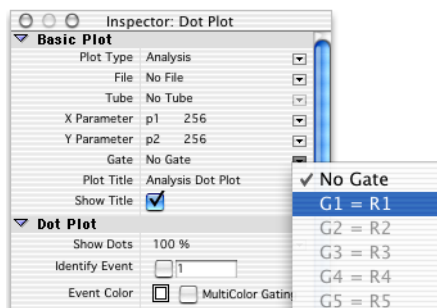

Adjusting Fluorescence Detector Settings

Fluorescence detector settings are adjusted to remove background fluorescence. Background fluorescence can result from nonspecific binding of antibodies in the isotype control and cell autofluorescence.

- 1 Verify that the Mode is set to Log for FL1, FL2, FL3 and FL4 in the Detectors/Amps window.
- 2 In the FL1 vs FL2 plot, drag the quadrant marker intersection to 10^1 on the x- and y-axes, respectively.

The markers will show areas of negativity and positivity.

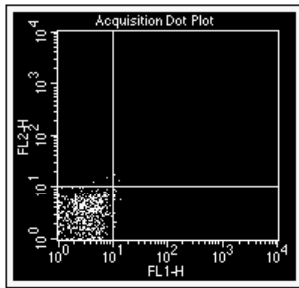

- 3 Install the isotype control tube on the SIP, if it was removed.
- 4 Click Acquire in Acquisition Controls.
- 5 In the Detectors/Amps window, adjust the FL1 and FL2 Voltages to place the negative population in the lower-left quadrant of the FL1 vs FL2 plot.

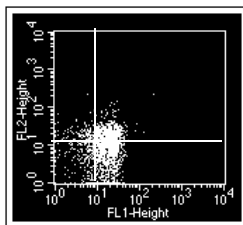

unadjusted

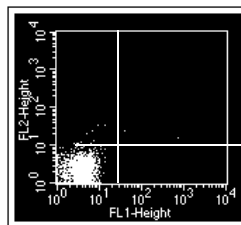

adjusted

- 6 If needed, adjust the FL3 voltage to place the negative population in the lower-left quadrant of the FL3 vs FL2 plot.
- 7 Click Pause in Acquisition Controls, and remove the tube from the SIP.
- 8 Close the Detectors/Amps and Threshold windows.

Adjusting Compensation Settings

It is important to choose appropriate reagents for compensation, based on the panel to be run. For each fluorophore, compensation should be set using the brightest stained population. For example, in a panel containing CD3 FITC, CD4 FITC, and CD8 FITC, set compensation using CD8 FITC, the brightest FITC-stained population in the panel.

Compensation settings are adjusted to correct for spectral overlap. Settings are dependent on the detector voltages established with the isotype control. Once voltages are set, compensation is adjusted on fluorescence-positive cells.

- 1 Choose Cytometer > Compensation, and drag the Compensation window to the side.
- 2 Place the FITC control tube on the SIP, and click Restart in Acquisition Controls.
- 3 If necessary, adjust FL2-%FL1 to place FITC-positive events in the lower-right quadrant of the FL1 vs FL2 plot.

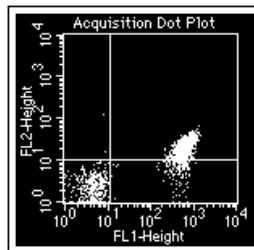
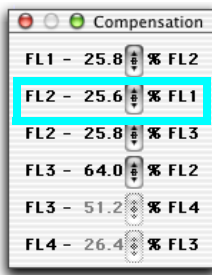

unadjusted

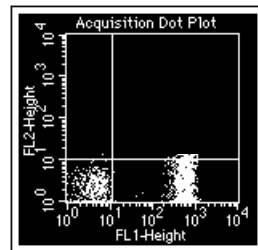

adjusted

- Tip** Compare the mean channel of the FL1-positive population with that of the negatives.

- 4 Remove the FITC tube and place the PE control tube on the SIP; click Pause and then Restart.
- 5 If necessary, adjust FL1-%FL2 to place PE-positive events in the upper-left quadrant of the FL1 vs FL2 plot.

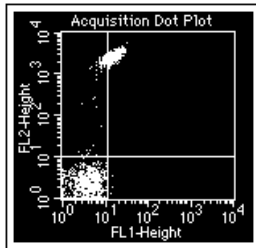

unadjusted

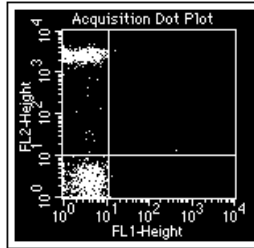

adjusted

- 6 If necessary, adjust FL3-%FL2 to place PE-positive events in the lower-right quadrant of the FL2 vs FL3 plot.

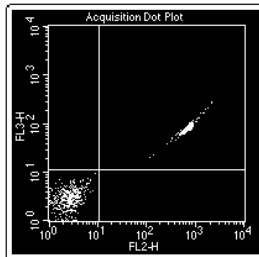

unadjusted

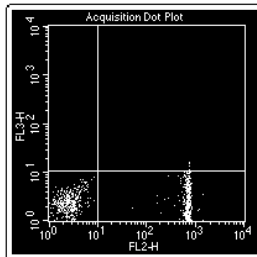

adjusted

- 7 Remove the PE tube and place the PerCP control tube on the SIP; click Pause and then Restart.
- 8 If necessary, adjust FL2-%FL3 to place PerCP-positive events in the upper-left quadrant of the FL2 vs FL3 plot.

It should be 0.0% because PerCP usually does not emit within a range that overlaps into the FL2 detector.

- 9 If necessary, adjust FL4-%FL3 to place PerCP-positive events in the lower-right quadrant of the FL3 vs FL4 plot.

- 10 If you are running 4-color samples, remove the PerCP tube and install the APC control tube on the SIP; click Pause and then Restart.

If necessary, adjust FL3-%FL4 to place APC-positive events in the upper-left quadrant of the FL3 vs FL4 plot.

- 11 Close the Compensation window.
- 12 Click Pause and then Abort in Acquisition Controls.
- 13 Remove the tube and place a tube of DI water on the SIP; press STNDBY.
- 14 (Optional) Choose File > Save Document.

If you made changes to the Standard Acq Experiment document, save the document in the location of your choice.

Saving Optimized Settings

Optimized settings can be saved to an instrument settings file that can be restored to the cytometer when you run lysed whole blood samples again. To restore settings, see page 89.

- 1 Choose Cytometer > Instrument Settings, and click Save.

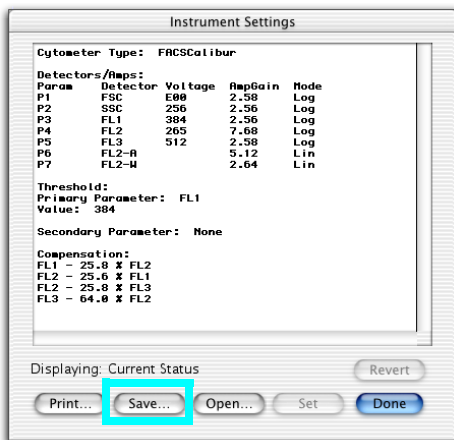

- 2 In the location dialog, enter a name of up to 31 characters, choose a file location, and click Save.
- 3 Click Done.

Acquiring Data

Before you save data, specify the file name and storage location, acquisition and storage settings, panel name and parameter labels (if applicable), and tube-specific settings (if applicable). These options are set in the Acquisition view of the Browser.

Specifying File Name and Storage Location

- 1 Open your acquisition Experiment document.

Use the Standard Acq document or the document you saved during optimization.
- 2 Choose Windows > Show Browser.
- 3 If needed, click the triangle to show Acquisition Controls:

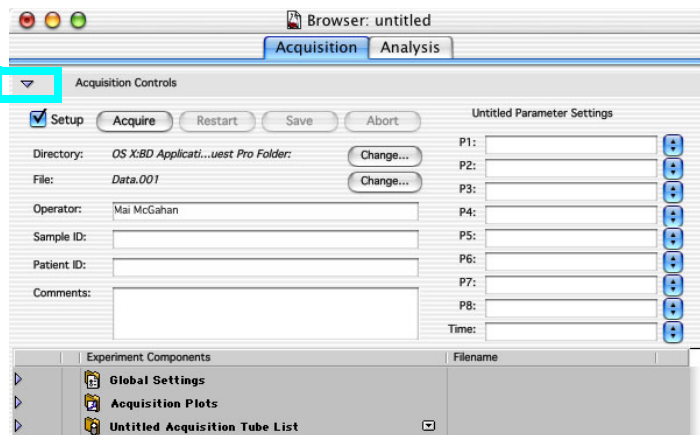

- 4 Click the Change button next to Directory; create or choose a data storage folder in the location dialog that appears.
- ✓ **Tip** BD recommends you do not save files directly to an external storage device such as a zip drive, file server, or remote computer. Save files to the hard drive and move them later.
- 5 Click the Change button next to File; specify a file name in the File Name Editor dialog.



- Choose the type of file name prefix. For Custom Prefix, enter a prefix in the Custom Prefix field. For Patient or Sample ID, enter information in the respective fields of the Acquisition Browser. (To use the Load Sample feature, you must enter a unique Sample or Patient ID before you acquire samples.)
 - Choose the type of file name suffix. For File Count (.*nnn*), the starting number is determined by the File Count field. Choose Tube Number if you are acquiring a panel. The tube number is appended to the file name.
- 6 Click OK; your choices appear in the Acquisition Browser.
 - 7 Enter an identifier (eg, *Donor 1*) in the Sample ID field of the Browser.
 - 8 Save the Experiment document.

Choose File > Save Document As, and enter a name for the document in the dialog that appears. Choose a storage folder, and click Save.

Specifying Acquisition and Storage Settings

Use Global Settings to define the number and type of events to acquire and store. Global settings apply to all tubes in an Experiment document that do not have tube-specific settings (page 108). Global settings are defined in the Acquisition & Storage dialog or Acquisition & Storage Inspector.

- 1 Choose Acquire > Global Acquisition & Storage.

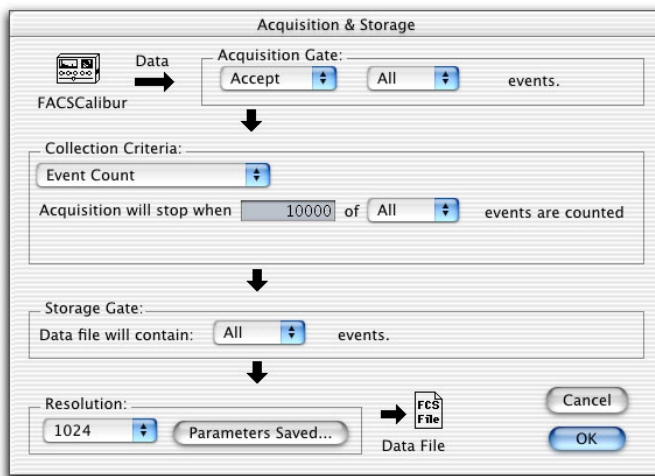

- Tip** Alternatively, to use the Inspector, open the Global Settings folder in the Acquisition Browser, and double-click the Global Acquisition & Storage Settings icon (Figure 5-2).

Figure 5-2 Acquisition & Storage Inspector

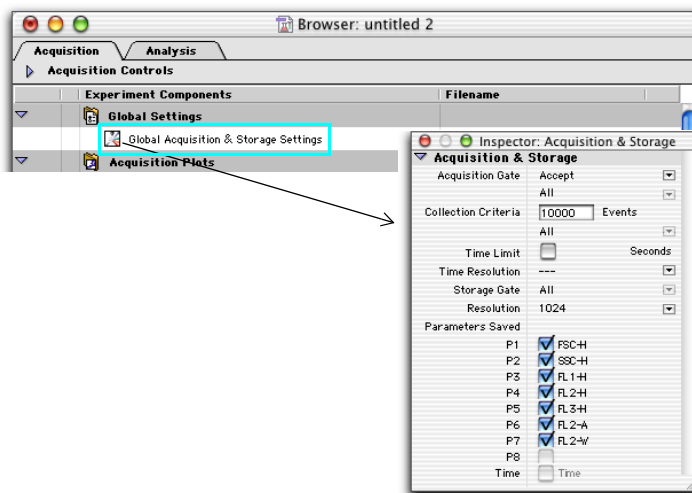

2 Make selections in the Acquisition & Storage dialog or Inspector.

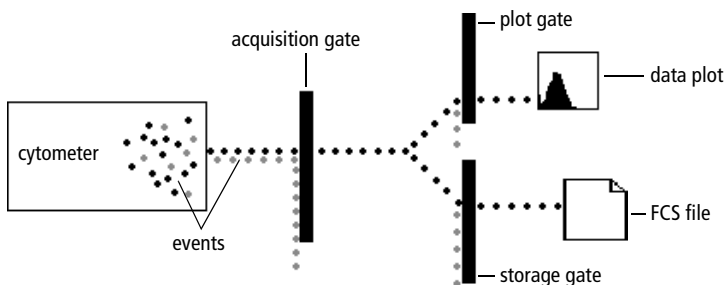

- The Acquisition Gate determines which events are available for data storage, display, and statistical calculations.
- Collection Criteria determine when acquisition will stop: after a set number of events (Event Count), time, or whichever comes first.
- The Storage Gate determines which events are saved in the data file. (Note that the storage gate does not affect which events can be shown in acquisition plots.)

For example, make the following selections.

- For Acquisition Gate, leave the defaults *Accept* and *All*.
- For Collection Criteria, enter 2,000 and choose G1 = R1.
- For Storage Gate, leave *All*.
- Keep the Resolution at 1024.

With these choices, data collection will stop when 2,000 events are counted within the G1 gate, but all data will be saved.

- 3 Click OK to exit the dialog or close the Inspector.
- 4 Save the Experiment document.

Specifying Parameter Labels (Optional)

Use parameter labels to associate reagent names with fluorescence parameters. Labels can be entered in the Browser, or associated with a panel.

Define a panel if you acquire the same reagent combination for multiple experiments or donors (page 104). Enter labels in the Browser if you are acquiring tubes stained with a unique reagent combination.

- Click the pop-up control next to a parameter name and choose a label from the menu that appears, or
- Enter a custom label in the parameter field. The new labels are saved with the Experiment document.

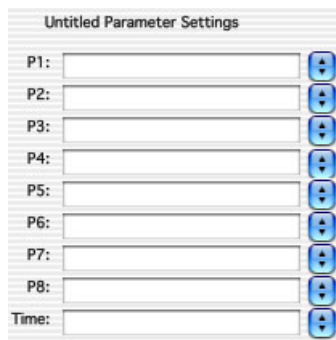

Defining Panels (Optional)

Parameter labels associate reagent names with fluorescence parameters. Labels can be entered in the Browser, or associated with a panel.

Enter labels in the Browser if you are acquiring tubes stained with a unique reagent combination (page 103). Define a panel if you acquire the same reagent combination for multiple experiments or donors.

- 1 Choose Acquire > Edit Panels.
- 2 Click Add.

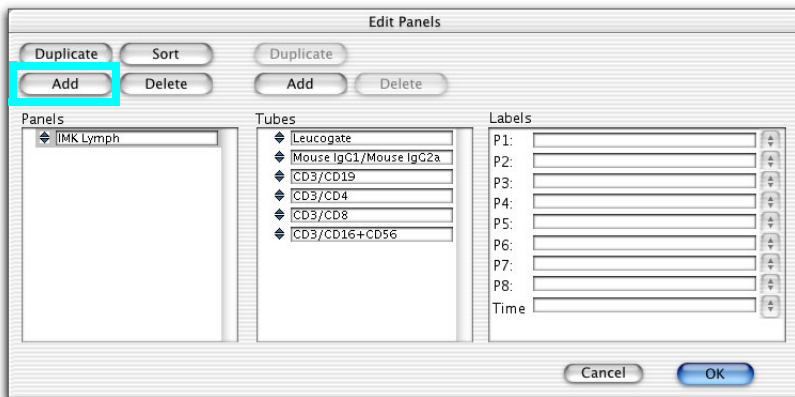

- 3 Enter a name for the new panel (up to 32 characters).

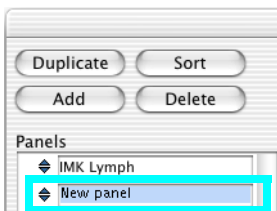

- Click the selection icon to select the panel, and click Add above the Tubes list.

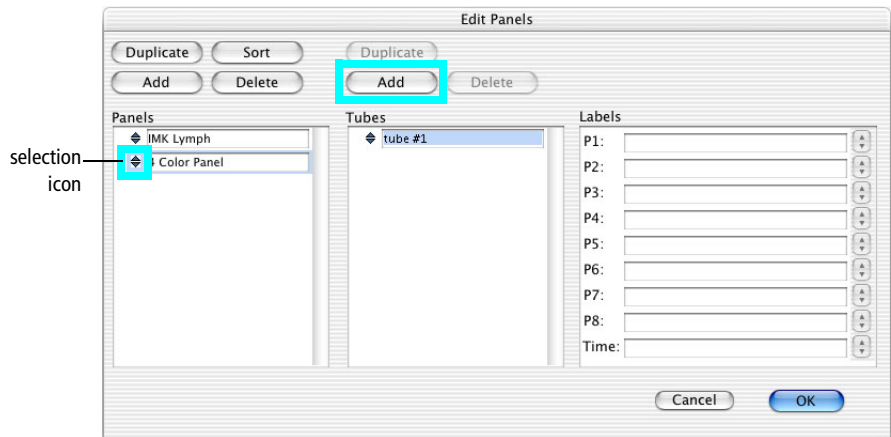

- Enter a name for the tube (up to 32 characters).
- Click the selection icon to select the tube, and choose parameter labels.

Click the pop-up control next to a parameter name and choose a label from the menu that appears, or enter a custom label. The new labels are saved with the Experiment document.

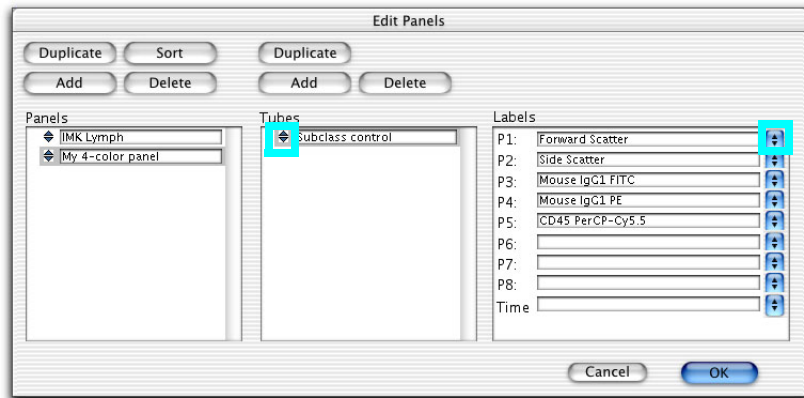

- 7 Click Add above the Tubes list to add another tube.
- 8 Enter a name for the tube and define parameter labels.
- 9 Repeat steps 7 and 8 for the remaining tubes in the panel; when finished, click OK.
- 10 Save the Experiment document.

Working With Panels in the Browser

Panels can be used to create an acquisition tube list. Once a tube list is defined, each tube can be associated with plots on the Experiment document. During acquisition, data is displayed in the associated plots and remains displayed until all tubes in the panel are acquired.

- 1 Click the pop-up control next to *Untitled Acquisition Tube List* and choose Load Tubes from Panel; select the panel you just created.

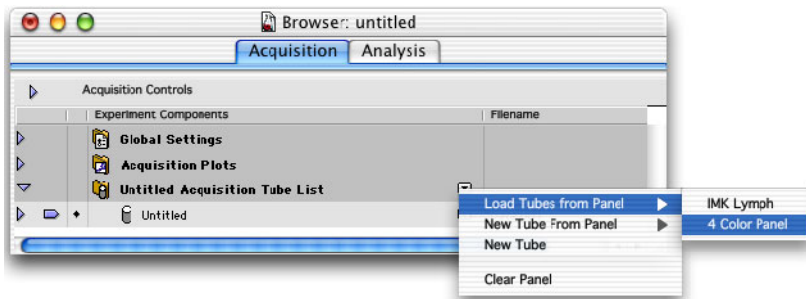

The Acquisition Tube List name changes to the name of the selected panel. Click the triangle next to the panel folder to display the tubes.

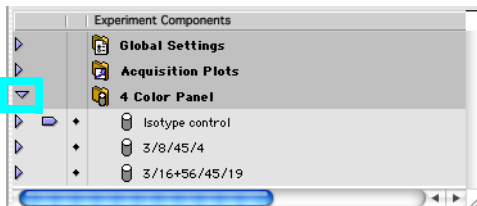

- 2 On your Experiment document, create the required number of plots; change all plots to Acquisition -> Analysis.
 - Press Command-A.
 - In the Inspector, choose Acq -> Analysis from the Plot Type menu.
- 3 Select one or more plots in the Experiment document or Acquisition Browser.

To display plots in the Browser, click the disclosure triangle next to the Acquisition Plots folder. Select multiple items by pressing the Shift key as you click.

- 4 In the Inspector, click the Tube pop-up menu and choose the tube you want to associate with the selected plots.

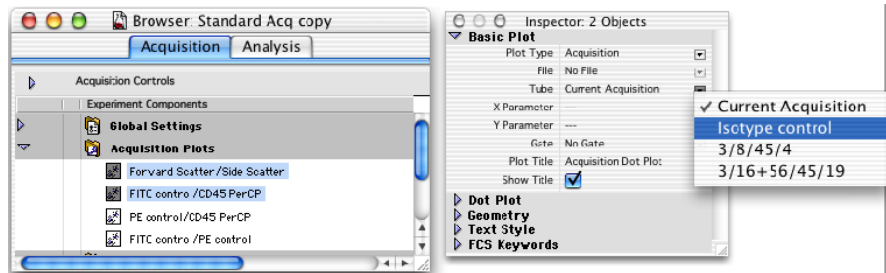

The associated plots are listed under the acquisition tube name in the Browser:

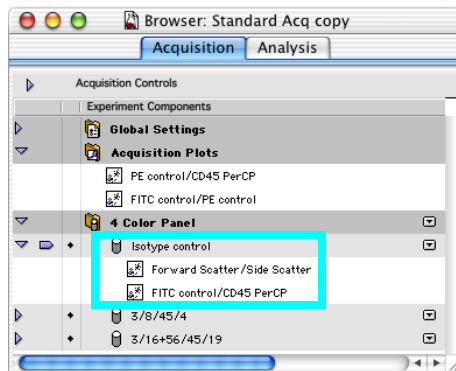

- 5 Continue associating tubes with plot(s) until each tube in the panel lists the required number of plots.

Specifying Tube-Specific Settings (Optional)

BD CellQuest Pro software allows you to associate custom instrument settings or acquisition and storage settings with any tube in the Browser. When no tube-specific settings exist, the tube will be acquired using global acquisition and storage settings or the current instrument settings for the Experiment document.

Adding Tube-Specific Acquisition & Storage Settings

Create tube-specific acquisition and storage settings when you want to acquire one tube with a different number of events to acquire, for example, or store the data in a custom location.

- 1 Click the pop-up control next to an acquisition tube, and choose Add Acquisition & Storage Settings.

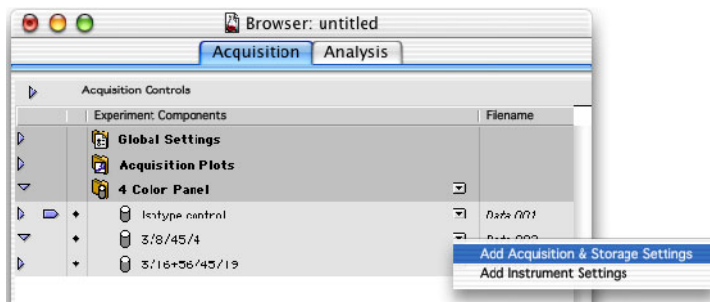

An Acquisition & Storage Settings icon is added below the tube:

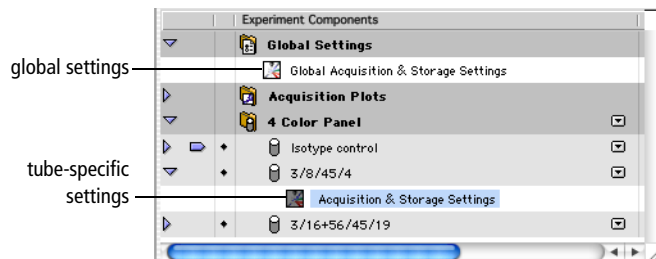

- 2 Double-click the Acquisition & Storage Settings icon.
- 3 In the Inspector, make any necessary changes to the current settings.
- 4 Repeat steps 1 through 3 for other tube-specific settings.
- 5 Save the Experiment document.

Adding Tube-Specific Instrument Settings

Create tube-specific instrument settings when you want to specify different settings for certain tubes in a panel. For example, if the panel contains samples stained with PerCP and PerCP-Cy5.5 reagents, you might want to associate different settings with PerCP tubes than PerCP-Cy5.5 tubes.

- 1 Click the pop-up control next to an acquisition tube, and choose Add Instrument Settings.

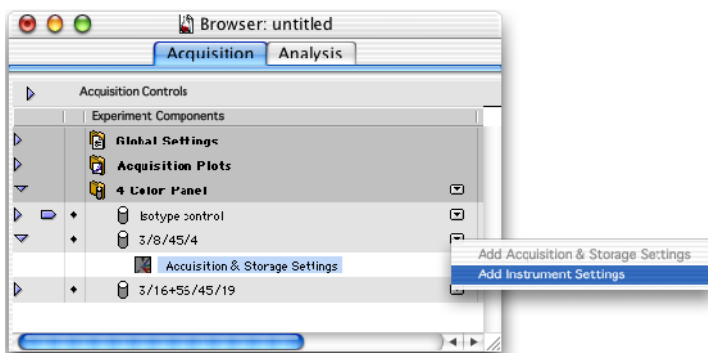

An Instrument Settings icon is added below the tube. The icon is crossed out until instrument settings have been defined.

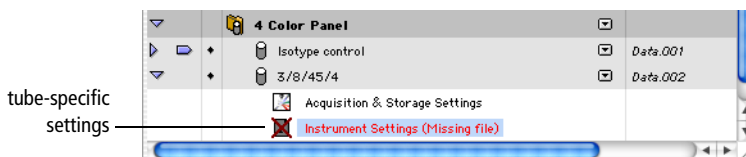

- 2 Double-click the Instrument Settings icon.

- 3 In the Inspector, click the File button and select an instrument settings file in the location dialog that appears.

The file name appears in the Inspector.

- 4 Repeat steps 1 through 3 for other tube-specific settings.
- 5 Save the Experiment document.

Saving Data

At this point, the electronics have been optimized for your cells, the gate and number of events to acquire and store have been established, and file storage has been defined. Data for each tube can now be saved.

- 1 Choose Acquire > Counters to display the Counters window, and drag the window to the side.

The Counters window has two sizes. Click the zoom button to enlarge the window if you are acquiring gated data.

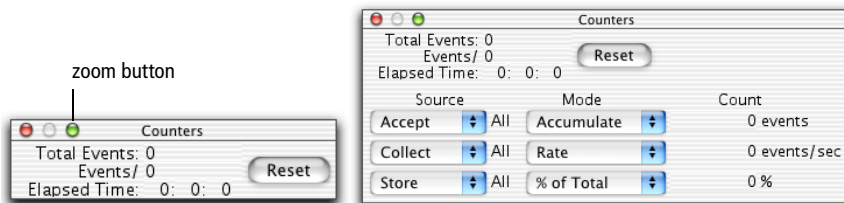

- 2 Deselect the Setup checkbox in Acquisition Controls.

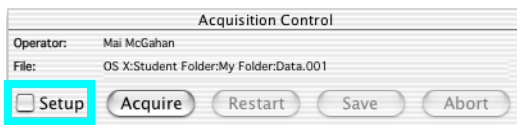

- 3** Verify the following:
 - The acquisition tube list contains all tubes in the proper order. If not, reorder the tubes or add or delete tubes.
 - The pointer is indicating the first tube to acquire.
 - Parameter labels in the upper pane of the Browser are correct.
- 4** Press RUN, and install the first sample tube on the SIP. Immediately place the support arm under the tube.
- 5** Wait approximately 5 seconds, and click Acquire.

NOTICE There is a brief period during which the sample tube is pressurized. It is important to wait for the pressure to stabilize before you click Acquire.

Live quadrant statistics are displayed as the data is acquired. The system beeps when acquisition is finished.

- 6** Remove the tube after the beep.

The pointer moves to the next tube in the Browser.
- 7** Verify the parameter labels are correct and place the next tube on the SIP.
- 8** Repeat steps 5 and 6 for the remaining tubes.
- 9** Install a tube of DI water on the SIP, and press STNDBY.

Checking Cytometer Status

When you are connected to the cytometer, use the Status window to check cytometer status during acquisition.

To access the window, choose Cytometer > Status.

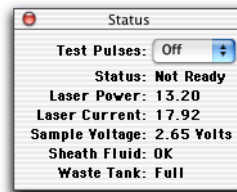

- For Status = NOT READY, verify
 - the blue laser is warmed up (it must be on 5 minutes before you run)
 - the sheath is full and/or waste is empty (Check the Sheath Fluid and/or Waste Tank status fields.)
- For Status = STANDBY, see if the fluid mode is STNDBY.

If in RUN, verify

- a sample tube is on the SIP
 - the tube support arm is under the tube
 - the tube is fully pressurized
- For Status = READY and no events displayed, see Acquisition Troubleshooting on page 191.

Analyzing Data

During analysis, acquired data from FCS data files is displayed in appropriate plots. Use regions and gates to restrict the analysis to populations of interest. BD CellQuest Pro software analyzes the data and calculates statistics that you can print or export.

The following sections demonstrate analysis features using sample data in the BD Applications > BD CellQuest Pro folder. The Sample Files folder contains 12 data files from 3 samples. Each sample was stained with the following 4-tube reagent panel:

Tube	Sample 1	Sample 2	Sample 3
Tube 1: γ_1 FITC/ γ_{2a} PE	NORM001	NORM005	NORM009
Tube 2: CD3 FITC/CD19 PE	NORM002	NORM006	NORM010
Tube 3: CD3 FITC/CD4 PE	NORM003	NORM007	NORM011
Tube 4: CD3 FITC/CD8 PE	NORM004	NORM008	NORM012

Creating an Analysis Document

- 1 Launch BD CellQuest Pro software, if necessary.

If the software is already running, select File > New Document.

- 2 Click the zoom button to expand the Experiment document window:

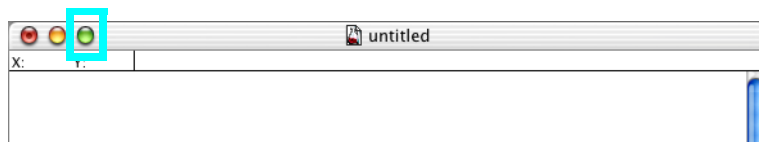

- 3 (Optional) Increase the number of Experiment document pages.

- Choose File > Document Size.

- Click rectangles to add additional pages (each rectangle represents one page).

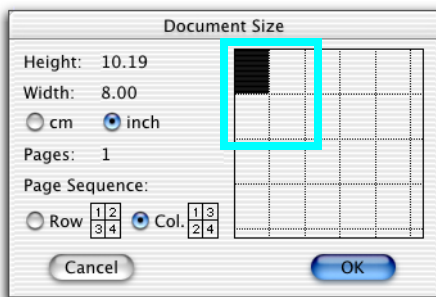

Tip Change page units or the print sequence using options in the dialog.

4 Create an Analysis dot plot.

- Select the Dot Plot tool () , click in the Experiment document window, and drag to set the plot size.
- Click the File pop-up control, and choose Select File.
- Navigate to BD Applications > BD CellQuest Pro > Sample Files, and double-click NORM001.

The plot shows data from the selected file.

- (Optional) Click the Event Color box and change the event color (Figure 5-3).

NOTICE To display FCS data files, you must first create a plot and then choose Select File in the Inspector. You cannot view an FCS data file by double-clicking its icon.

5 Create a region around the lymphocytes in the dot plot.

Tip Use the Snap-To tool () to draw a quick and simple region. Select the tool, and click the lymphocyte population. A gate is automatically drawn.

Your dot plot and Inspector should look similar to Figure 5-3.

Figure 5-3 Analysis dot plot with Snap-To lymphocyte region

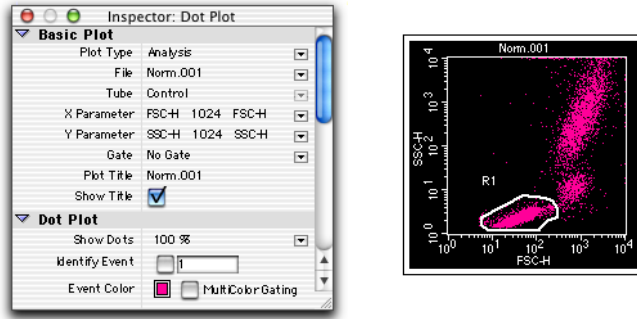

- 6 Create an Analysis FL1 vs FL2 contour plot showing lymphocyte-gated data from NORM001.
 - Choose Plots > Contour Plot. (This creates a plot the same size as the dot plot.)
 - In the Contour Plot Inspector, click the File pop-up control, and choose NORM001.
 - Choose FL1-H for the X Parameter, and FL2-H for the Y Parameter.
 - Choose G1 = R1 for the Gate.
 - (Optional) Click the Color box and choose a new color (Figure 5-4).
- 7 Create quadrant markers () around the negative population in the contour plot.

Select the Quadrant Marker tool, and drag to set the intersect point so the subclass population is in the lower-left quadrant. Your contour plot and Inspector should look similar to Figure 5-4.

Figure 5-4 Analysis contour plot with quadrant markers

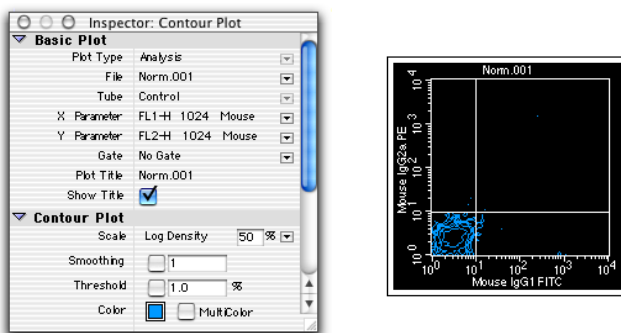

- 8 Create an Analysis FL1 histogram displaying NORM001 gated data.

(Optional) Change the Line and Fill colors in the Inspector.

- 9 Draw a histogram marker () around the negative population (Figure 5-5).

Select the Histogram Marker tool and click to set the left edge of the marker. Drag to set the right edge of the marker; release the mouse to complete it.

- 10 Draw a second histogram marker from the upper boundary of marker 1 to the end of the histogram plot.

Your histogram plot and Inspector should look similar to Figure 5-5.

Figure 5-5 Analysis histogram with histogram markers

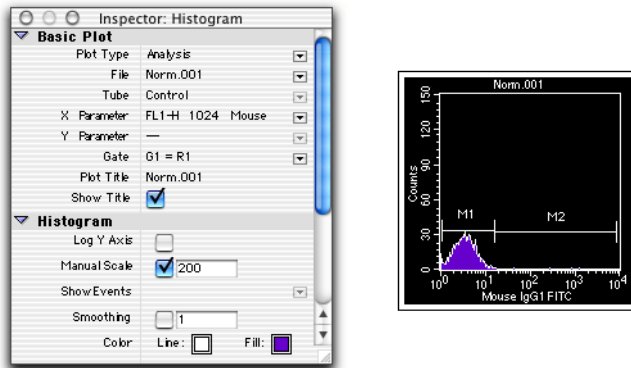

Displaying Statistics

- 1 Select the contour plot, and choose Stats > Quadrant Stats.

The Quadrant Statistics view appears showing data from NORM001.

- 2 Select the Quadrant Statistics view and choose Stats > Edit Quadrant Stats.
- 3 Deselect all choices except File Name, Gate, Parameters, Quadrant Label, Percent of Gated, and Percent of Total; select 1 Column for the Header.

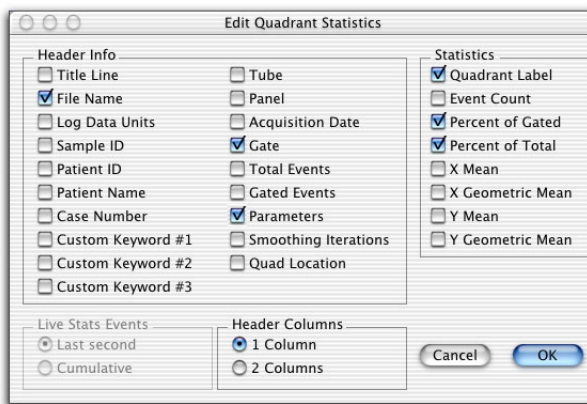

- Click OK; resize and reposition the resulting Quadrant Statistics view.

Drag one of the handles to resize the view; drag the border to move the view next to the FL1 vs FL2 contour plot.

File: Norm.001
Gate: G1
X Parameter: Mouse IgG1 FITC (Log)
Y Parameter: Mouse IgG2a PE (Log)
Quad % Gated % Total
UL 0.14 0.07
UR 0.07 0.03
LL 98.78 48.45
LR 1.02 0.50

The calculated statistics for NORM001 show that most of the gated events fall in the lower-left (LL) quadrant. In this example, 98.94% of the gated events are negative for FL1 and FL2 which would be expected because the subclass control accounts for nonspecific antibody binding.

- Select the histogram, and choose Stats > Histogram Stats.

The changes you made in the Edit Quadrant Statistics dialog also apply to the histogram statistics. Move the statistics view next to the histogram.

File: Norm.001
Gate: G1
X Parameter: Mouse IgG1 FITC (Log)
Marker Left, Right % Gated % Total CV Median Peak Ch
All 1, 9910 100.00 49.05 627.65 3.37 3
M1 1, 16 98.37 48.25 48.21 3.40 3
M2 16, 8660 0.20 0.10 91.50 455.20 16

- Save the Analysis document.

- Print the results for NORM001.

Tip Choose File > Print One to print a single copy.

Analyzing Groups of Files

Use the batch analysis feature to analyze a group of data files in an Analysis Experiment document. Batch analysis allows you to increment files, pause between data sets, print automatically, and export statistics to a spreadsheet file.

- 1 Choose Batch > Setup, and make the following selections:

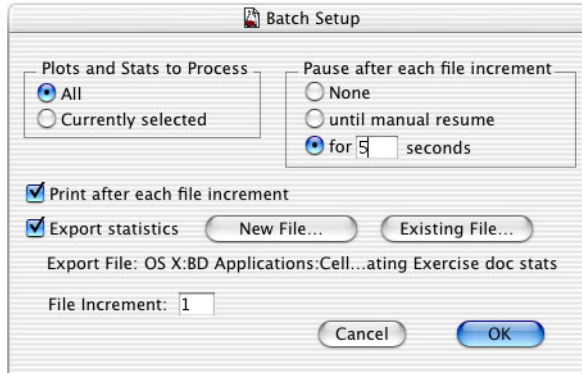

- When *All* is selected under *Plots and Stats to Process*, data will be processed using all plots in the document.
- When *for [n] seconds* is selected under *Pause after each file increment*, the batch will pause for *n* seconds after each file is processed.
- When the *Print after each file increment* checkbox is selected, the document prints automatically after each file is processed.
- When the *Export statistics* checkbox is selected, the statistics from each statistics view are exported to a file that you can open in a third-party application such as Microsoft® Excel.
- The *File Increment* field instructs the software to increment that number of files when running batch analysis. For example, if 2 is entered and the first data file is .001, the next file analyzed would be .003.

- 2 For exported statistics, click the New File button.

A save dialog box appears.

- 3** Specify the file name and folder destination, and click Save.
- 4** Click OK in the Batch Setup dialog.
- 5** Choose Batch > Run.

A batch control window appears. To interrupt batch analysis, click stop, pause, or resume anytime during the run.



A message appears when the batch run is finished:

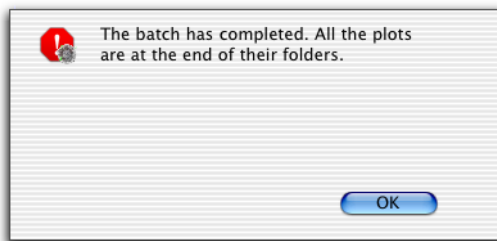

Running Samples with BD Multiset Software

This section describes how to launch and run BD FACSCComp within BD Multiset software, and how to acquire and analyze data.

Setting Up

1 Launch BD Multiset software:



2 At the Sign In view, enter at least the Operator name and click Accept.

Tip Enter your institution name to display it at the top of Lab, Physician, and Summary Reports.

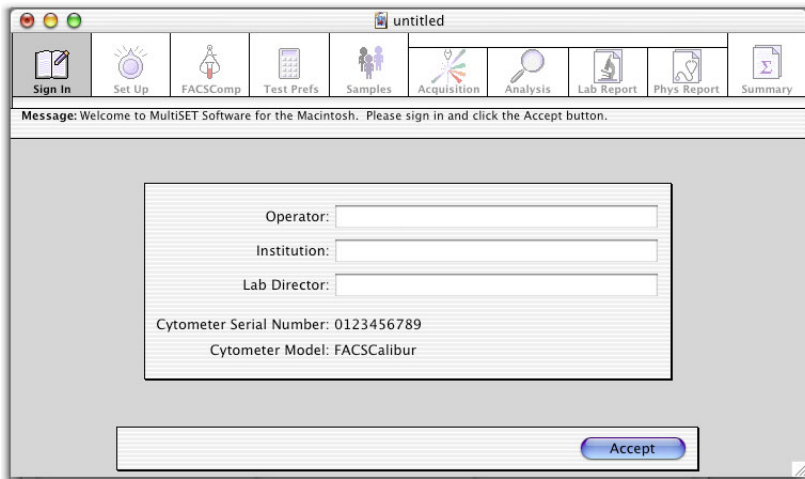

3 At the Set Up view, select a Data Source.

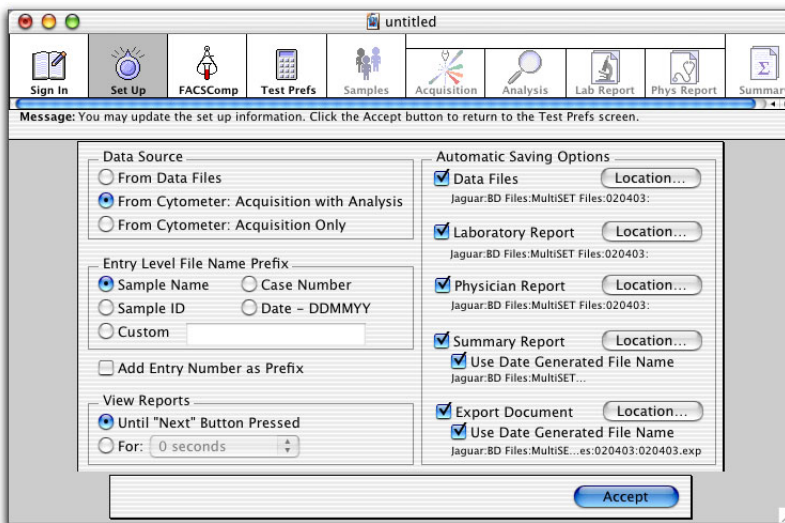

- Select *From Data Files* to analyze saved data files.
- Select *From Cytometer: Acquisition with Analysis* to run stained samples and analyze data automatically after each sample is acquired.
- Select *From Cytometer: Acquisition Only* to run stained samples without analysis.

4 Under Entry Level File Name Prefix, select a prefix for data files, Physician Reports, and Lab Reports.

- For Sample Name, Sample ID, or Case Number, make entries in the corresponding column of the Samples view.
- For Custom, enter a prefix in the box.
- To insert the schedule entry number before the prefix (eg, 01JaneDoe.lab), select *Add Entry Number as Prefix*. When deselected, the entry number appears after the prefix: JaneDoe01.lab.

- 5 Under View Reports, select how long to view reports.
- 6 Under Automatic Saving Options, click the checkbox for each file you want to save; click the Location button to change the default name or storage location.

A dialog appears where you can enter a new name or different storage location. For file types and default names and locations, see page 45.

Tip For Export Documents, append data by selecting an existing Export Document file in the Choose Location dialog.

- 7 Click Accept.
 - When Data Source = From Data Files, the Test Prefs view appears. Skip to page 126.
 - When Data Source = From Cytometer, the FACSComp view appears showing the name, date, time, and status of the most recent Calib file.

NOTICE These calibration settings are *not* automatically downloaded to the cytometer.

Running BD FACSComp

Tip If you are running manually, make sure Run With the Loader is deselected in BD FACSComp preferences.

- 1 If the current Calib file is old or invalid, click Launch FACSComp.

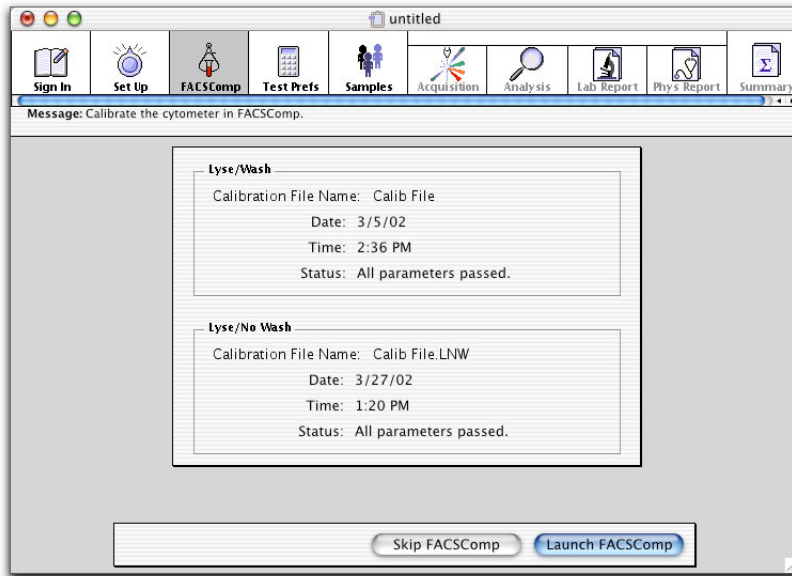

Otherwise, click Skip FACSComp to proceed to the Samples view where you can retrieve saved settings and download them to the cytometer (page 128).

- 2 At the BD FACSComp Set Up view under Assay Selection, select only the Lyse/No-Wash (LNW) assay.
- 3 Prepare BD Calibrite beads and perform instrument QC.

Instrument settings are saved to Calib File.LNW if all parameters pass the Sensitivity Tests.

Optimizing Settings

The instrument settings in Calib File.LNW are appropriate for LNW samples but can be optimized for SSC and FL3 threshold settings. For details on optimizing settings in BD FACSCComp software, see page 79.

Tip If running both BD Tritest and BD Multitest samples, optimize once with BD Multitest samples. If your BD Tritest panel includes both CD4/CD8/CD3 and CD3/CDX/CD45, optimize using the CD4/CD8/CD3 tube.

- 1 At the BD FACSCComp Summary view, click Optimization.
- 2 Choose MultiTEST.opt from the Optimization menu.
- 3 Install any of the control or sample tubes on the SIP, and click Start.
- 4 Adjust the SSC PMT setting, if needed.
- 5 Adjust the FL3 threshold to exclude most of the debris.

A small amount of debris should be present to properly set the Expert Gate. *Do not* modify the fluorescence PMT detector or compensation settings.

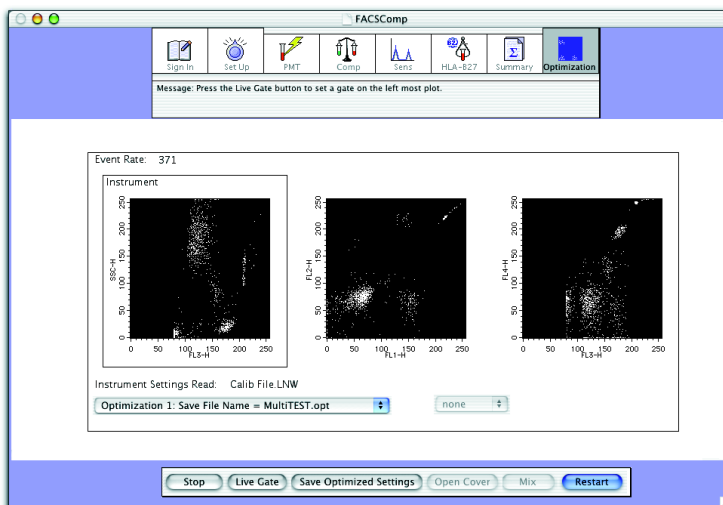

6 Click Save Optimized Settings.

A file name and location dialog appear if optimized settings have already been saved with the default name. Click Overwrite to overwrite the file with the current settings.

7 Click Quit within BD FACSCComp, and Continue within BD Multiset.

Entering Test Preferences

At the Test Prefs view, you make analysis and reporting choices. You can also access the Lot IDs dialog to enter BD Trucount bead information.

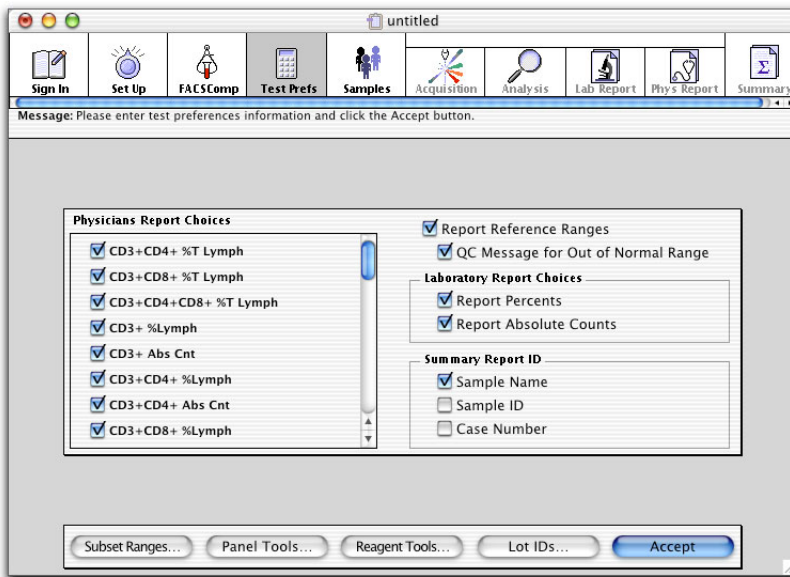

1 Under Physicians Report Choices, select subsets to show on the Physician Report.

All subsets for BD-defined reagents are listed. Selected subsets will be shown on the report if reagents producing these results are part of the entry's panel.

- 2 Select Report Reference Ranges if you want reference ranges to appear on the Lab and Physician Report.

Reference ranges are defined in Subset Ranges. The range selected in Panel Tools is the one shown on Lab and Physician Reports.

To show a QC message when a result is out of range, ensure the *QC Message for Out of Normal Range* checkbox is selected.

- 3 Under Lab Report Choices, specify which results to include.

Choose percentages, absolute counts, or both. The information is reported on both Lab and Physician Reports.

- 4 Under Summary Report ID, select at least one ID.

All samples are listed in the Summary Report with the specified ID(s). You must enter information in the specified fields at the Samples view.

- 5 If you are using BD TruCount tubes, click Lot IDs, and click Absolute Count Beads.

The screenshot shows a dialog box titled "Lot IDs" with a sub-title "Absolute Count Bead Lot IDs". On the left side, there is a vertical menu with three options: "Reagents", "Absolute Count Beads", and "Control Beads". The "Absolute Count Beads" option is highlighted with a red rectangular box. The main area of the dialog contains the following fields:

- Bead Name:** TruCount
- Lot ID:** 00000
- Beads/Pellet:** 50000

At the bottom of the dialog, there are two buttons: "Cancel" and "Save".

- 6 Enter the Lot ID and Beads/Pellet information from the BD Trucount foil pouch label, and click Save.



Make sure the correct information is entered per run. This information is critical for calculating accurate absolute counts. Only one lot ID can be entered per Schedule document.

- 7 At the Test Prefs view, click Accept.

Entering Sample Information

You must enter sample information whether the Data Source is From Cytometer (acquisition) or From Data Files (analysis only), but you cannot mix acquisition and analysis entries in the same Schedule document. This section describes how to enter sample information for acquisition; for analysis only, see page 137.

- Tip** To enter information automatically, use a barcode scanner. Use any barcode except 2 of 5, because errors can occur when the scanner is not correctly horizontal across the bars. This code has no check for begin/end of barcode.

- 1 Click in the first required field, and enter information.

	Sample Name	Sample ID	Case Number	Column #3	Panel Name	WBC Coun
<input type="radio"/> 1						0.0
<input type="radio"/> 2						0.0
<input type="radio"/> 3						0.0

At the minimum, enter information for the file name prefix selected in the Set Up view, and for the Summary Report ID field(s) selected in Test Preferences. The message box shows which fields are required.

2 Choose the panel you want to run.

Click in the Panel Name field, click the pop-up control, and choose a panel.

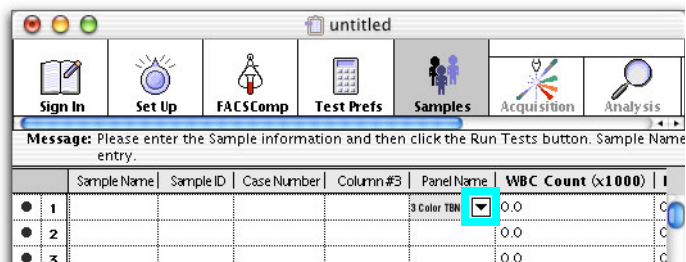

Tip If you always run the same panel, use Panel Preferences to set that panel to appear by default.

3 Choose one of the following methods to calculate absolute counts if you are **not** using BD Trucount tubes.

Tip For user-defined reagents, you must also choose a lymphocyte population for the absolute count calculation. Click Edit Subset Results in Reagent Tools.

- Enter the WBC count (0.0–999.9) and % Lymph (0.0–100.0) obtained from a hematology instrument,

OR

- Enter an absolute lymphocyte count (0.00–999.9) obtained from a hematology instrument.

NOTICE Do not enter both.

For accurate calculation of absolute counts when using hematology inputs, CD45 must be used for FL3.

NOTICE Do not enter information in the WBC or Lymph fields if one or more reagents in the panel is used with BD Trucount tubes.

- 4 Choose Cytometer > Instrument Settings to download instrument settings.

BD Multiset software, run as a standalone application, does not automatically download instrument settings. You can manually download settings at the Samples, Lab Report, Phys Report, and Summary views.

If you run samples requiring different optimized settings, download settings at the Phys Report view between panels.

- Navigate to the BD Files > Instrument Settings Files and double-click TriTEST.opt or MultiTEST.opt. (You can also use Calib file.LNW or any saved instrument settings file.)
- Click Set, and then Done.

- 5 Choose File > Save to save the Schedule document.

Acquiring Data

At the Acquisition view, sample data is shown in plots before and during acquisition. Data is not saved until you click Acquire. Once a sample has been run on the cytometer, sample information in the Samples view cannot be edited.

- 1 Vortex and install the first control tube on the SIP.
- 2 Press RUN and HI.
- 3 Click Run Tests at the Samples view.

Events appear in plots (Figure 5-6).

Figure 5-6 Previewing BD Multitest data

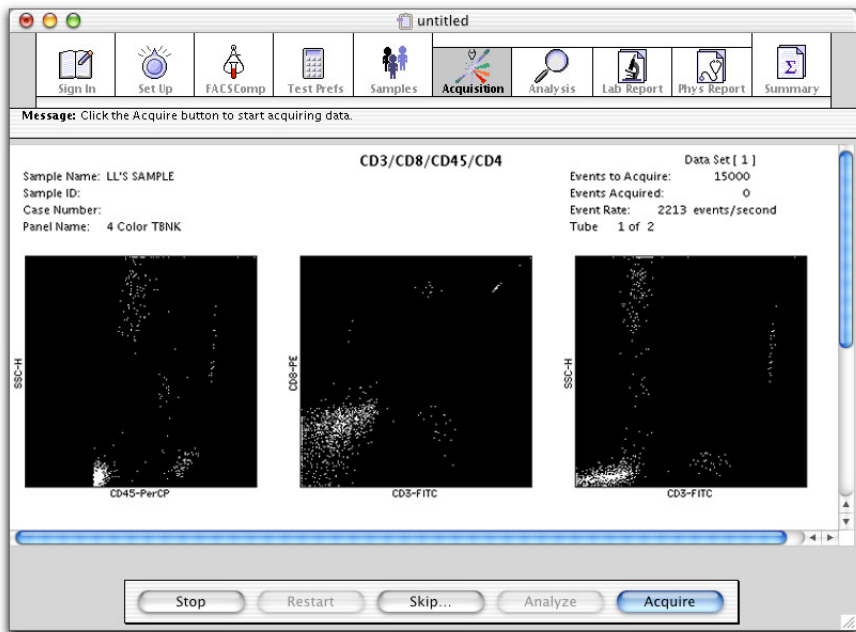

4 Click Acquire.

Acquisition proceeds until the designated number of events is acquired (Events Preferences). The software then checks to see if the minimum target population events (Reagent Tools) have been collected. If the target number has been reached, BD Multiset proceeds with analysis. If the target number has not been reached, the software calculates the additional number of events needed.

5 Review data on the Lab Report and make manual adjustments, if needed (page 133).

6 Vortex and then install the next tube on the SIP.

7 Verify RUN is on, and click Continue.

The software proceeds with acquisition and analysis of the next tube.

After the last tube in the panel, multi-tube QC values are shown on the report.

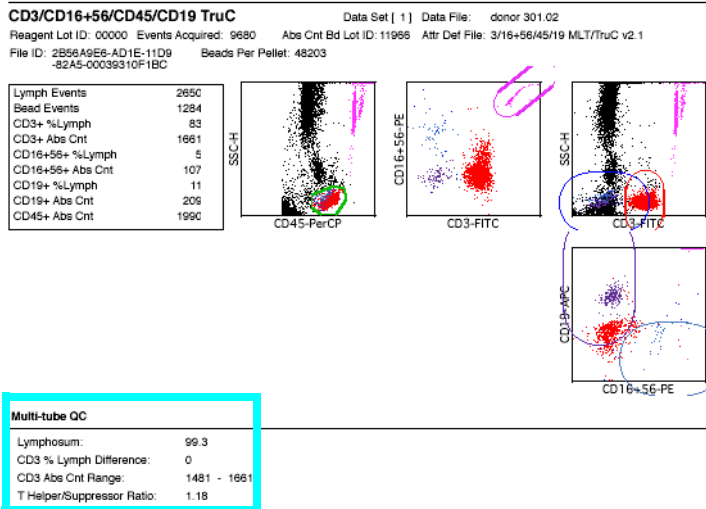

8 (Optional) Click Rerun to rerun any tube in the panel.

NOTICE Do so before you proceed to the Phys Report view.

9 Click Continue.

The Lab Report prints if automatic printing was chosen in Printing Preferences and the Phys Report view appears (page 136).

10 Click Next at the Phys Report view.

The Physician Report prints if automatic printing was chosen in Printing Preferences.

11 Install the first sample tube of the next panel on the SIP; repeat steps 4 through 10 until all samples have been run.

12 Review the Summary Report (page 137).

13 Install a tube of DI water on the SIP, and press STNDBY.

Reviewing Lab Reports

Although BD Multiset is a very sophisticated software, a technologist must review all data plots before signing the results. The operator should verify that adequate lymphocyte events were collected, and that attractors are correctly placed. If an insufficient number of lymphocytes were collected (ie, less than the BD or user-defined criteria), the sample must be reacquired with a new FL3 threshold to increase the number of collected cells. The new threshold is acceptable as long as it does not cut through the lymphocyte population.

If you are running Acquisition With Analysis, the Lab Report view appears after each tube is run. The view pauses for the amount of time specified in Set Up; you can inspect plots during the pause.

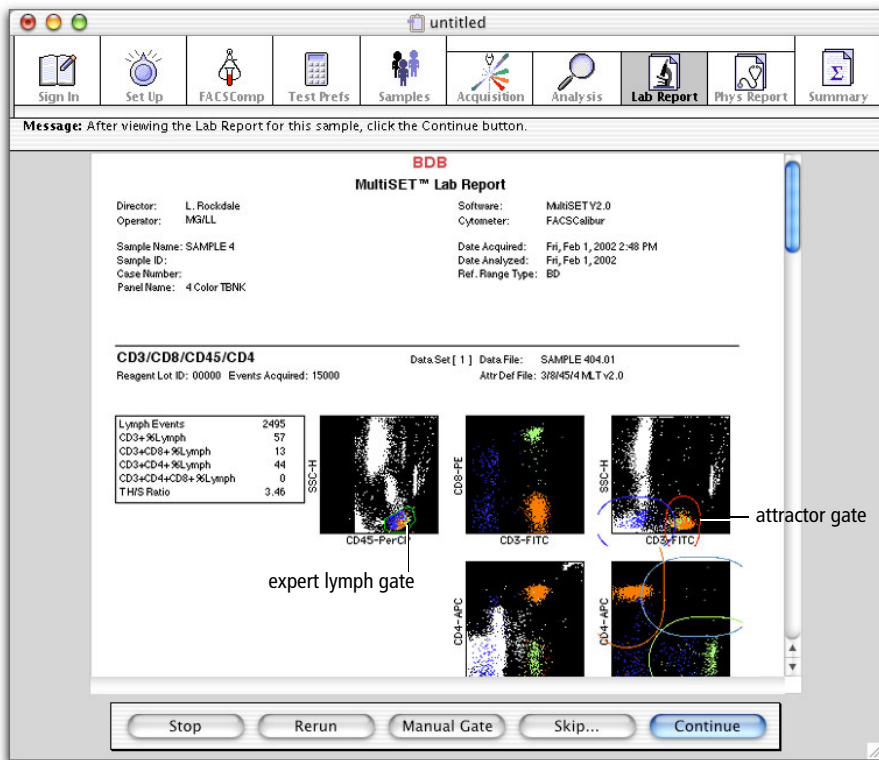

After previewing the report, use manual gating to adjust the expert lymph gate or attractors, if needed. For results troubleshooting, see page 203.

Manual Gating

NOTICE Changes made to the gate, attractors, or display are applied to the current tube only.

- 1 Click Manual Gate.
- 2 To re-draw the expert lymph gate, double-click the CD45 vs SSC plot.

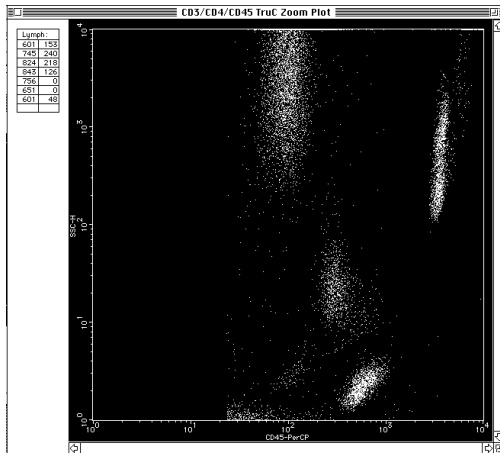

- 3 Create a polygon region around the lymphocytes.
 - Move the cursor near the lymphocytes and click to start the region.
 - Click around the population of interest until the region is complete.
 - Close the region by double-clicking the last vertex or clicking the first.
- 4 Click the close box.
- 5 Select any attractor gate to adjust it.

You can move, resize, and reorient attractors, but you cannot delete them or add new ones.

- To move an attractor, drag the center point.
- To change the orientation and length, drag an endpoint.
- To change the size, drag an edge.

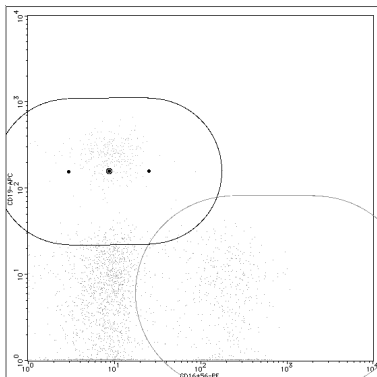

6 Click Analyze.

This confirms changes and recalculates results. The QC Message area of the Lab Report indicates a manual gate has been set.

7 (Optional) Save attractor changes.

Expert lymph gate changes cannot be saved.

- Choose File > Save Reagent.
- Enter a unique name, or keep the default name.
- Click OK.

Changes are saved as a user-defined reagent that can be reused the next time a tube with the same reagent combination is analyzed.

Reviewing the Physician Report

The Physician Report summarizes results for one sample. It contains all results for each reagent in a panel as specified in Test Prefs. If more than one reagent in a panel provides a particular subset result, the average subset result is reported. The report also shows multi-tube QC results, and has a field where you can enter comments.

BDB
Multiset™ Physician Report

Director: OSX Software: Multiset V2.0
Operator: MG Cytometer: FACSCalibur

Sample Name: M3OSX01FCD3 Date Acquired: Wed, Apr 3, 2002 1:36 PM
Sample ID: Date Analyzed: Wed, Apr 3, 2002
Case Number: Reference Range Type: BD
Panel Name: 3 Color TBK + TruC

Result Name	%/Ratio	Abs Cnt (cells/µL)	Reference Range
T Lymphs % of Lymphs (CD3+CD45+)	54 Lo		55% — 84%
T Lymphs (CD3+) Abs Cnt		654 Lo	690 — 2540
T Helper % of Lymphs (CD3+CD4+CD45+)	12 Lo		31% — 60%
T Helper Lymphs (CD3+CD4) Abs Cnt		143 Lo	410 — 1590
Lymphocyte (CD45+) Abs Cnt*		1206	
T Suppressor % of Lymphs (CD3+CD8+CD45+)	37		13% — 41%
T Suppressor Lymphs (CD3+CD8+) Abs Cnt		503	190 — 1140
B Lymphs % of Lymphs (CD19+CD45+)	37 Hi		6% — 25%
B Lymphs (CD19+) Abs Cnt		408	90 — 660
NK Lymphs % of Lymphs (CD16+56+CD45+)	35 Hi		5% — 27%
NK Lymphs (CD16+56+) Abs Cnt		396	90 — 590

*For quality control purposes only

Multi-tube QC

Lymphosum: 125.9
CD3 % Lymph Difference: 2
CD3 Abs Cnt Range: 610 - 729
T Helper/Suppressor Ratio: 0.32

Comments:

Verbal Order Laboratory Director: _____

Stop Comments Next

Reviewing the Summary Report

The Summary Report appears after the last sample in the schedule has been run. The report contains a list of all entries in the Schedule document; it has no editable fields.

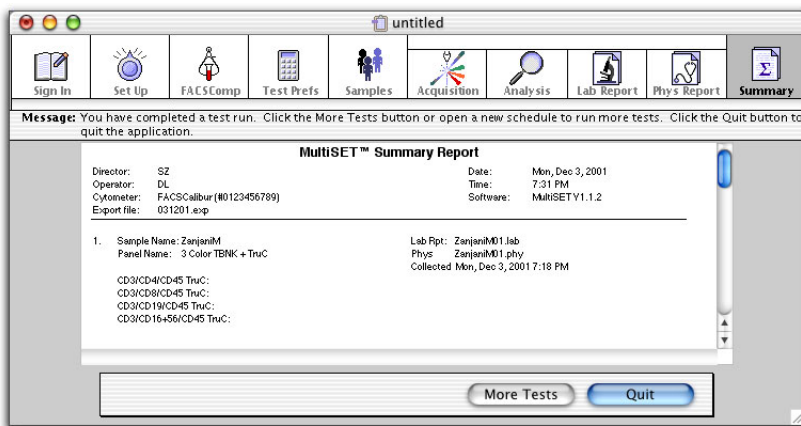

Analyzing Data

BD Multiset software can analyze FCS 2.0 data files acquired in BD Multiset, BD CellQuest version 3.1 or later, or BD CellQuest Pro software. The files must be 1024 resolution, with 3–6 parameters (FSC, SSC, FL1-H, FL2-H, FL3-H, FL4-H). All files per sample must have the same file name prefix.

NOTICE You cannot mix cytometer-based entries with data file-based entries in the same Schedule document. During setup, select *From Data Files* as the Data Source in the Set Up view.

- 1 From the Samples view, click Add Samples.



- 2 Choose files for analysis (Figure 5-7).

Double-click any available file. By default, *Filter for first tube in panel* is checked, so only the first file from a panel is available. When you select this file, other files in the panel are automatically added.

Figure 5-7 Choosing files for analysis

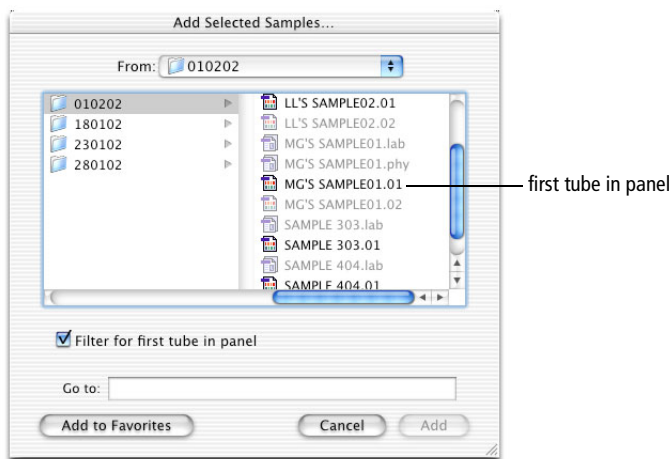

NOTICE BD CellQuest Pro files, version 4.0 or later, can be similarly filtered if they were created using a panel whose name is recognized by BD Multiset software. If there is no match, all files are enabled. Select only the first tube's file in each panel to add all files for the panel.

The Samples view appears, listing all selected files.

To delete a sample, click the sample number to select the entire row, and press Delete.

Tip Although you cannot edit ID information read from the file, you can enter new ID information or change WBC and lymph values. You can also change the panel type and add information to blank fields. The added information can be saved with the Schedule document, but not with the data file.

3 Click Run Tests.

NOTICE The Return key does not work at this view.

The Acquisition view appears briefly while data is read from the first file. You can then view data on the Acquisition and Lab Report views for each tube, the Phys Report view for each panel, and the Summary view for the run.

Running Samples with BD HLA-B27 Software

This section describes how to launch and run BD FACSComp within BD HLA-B27 software, and how to acquire and analyze data.

Setting Up

- 1 Launch BD HLA-B27 software: 
- 2 At the Sign In view, enter at least the Operator name and click Accept.

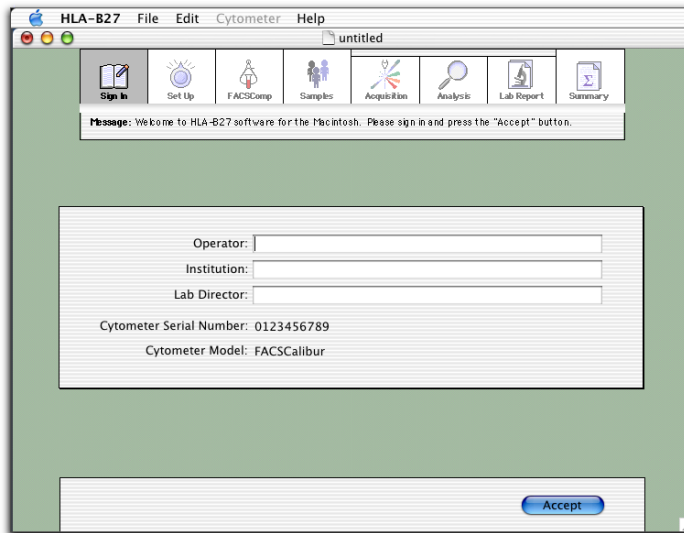

3 At the Set Up view, select a Data Source.

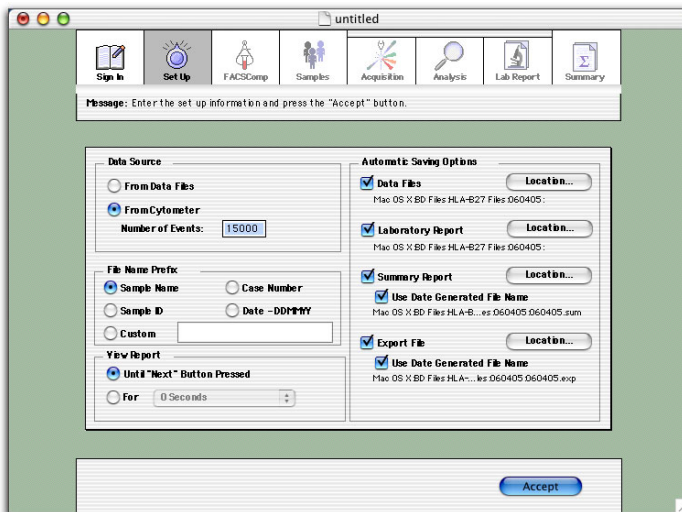

- Select *From Data Files* to analyze saved data files.
- Select *From Cytometer* to run stained samples and analyze data automatically after each sample is acquired. Enter the number of events to acquire (15,000–50,000) or leave the default value.

4 Select a File Name Prefix for data files and Lab Reports.

- For Sample Name, Sample ID, or Case Number, make entries in the corresponding column of the Samples view.
- For Custom, enter a prefix in the box.

5 Under View Reports, select how long to view reports.

6 Under Automatic Saving Options, click the checkbox for each file you want to save; click the Location button to change the default name or storage location.

A dialog appears where you can enter a new name or different storage location. For file types and default names and locations, see page 50.

 **Tip** For Export Files, append data by selecting an existing Export File in the Choose Location dialog.

7 Click Accept.

- When Data Source = From Data Files, the Samples view appears. Skip to page 146.
- When Data Source = From Cytometer, the FACSComp view appears showing the date, time, and status of the most recent BD FACSComp and HLA-B27 calibration.



BD Biosciences recommends rerunning calibration if calibration files are older than 24 hours.

Running BD FACSComp

- 1 If the current Calib file is old or invalid, click Launch FACSComp.

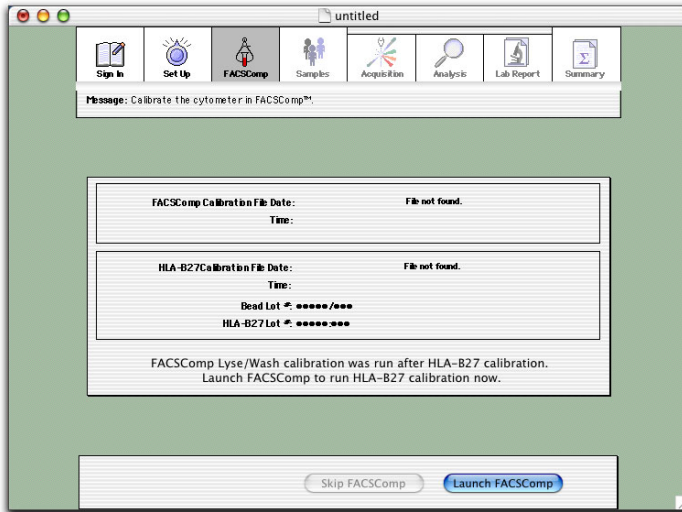

Otherwise, click Skip FACSComp to proceed to the Samples view (page 143).

- 2 At the BD FACSComp Set Up view under Assay Selection, select the checkboxes for Lyse/Wash and HLA-B27 Calib.
- 3 Enter BD Calibrite bead lot IDs from the sticker packaged with the BD Calibrite Beads kit.
- 4 Enter HLA-B27 bead and reagent lot IDs and suffixes from reagent vials in the BD HLA-B27 kit.



Make sure the correct information is entered per run. This information is critical for providing accurate results. Only one lot ID can be entered per Schedule document.

- 5 Run the Lyse/Wash option for at least a two-color setup with unlabeled, FITC-, and PE-labeled beads.
- 6 Run HLA-B27 calibration with BD HLA-B27 beads.
- 7 When complete, quit BD FACSCComp software.
 - If both calibrations are successful, the BD HLA-B27 Samples view appears.
 - If either calibration is unsuccessful, the BD HLA-B27 FACSCComp view appears. Click Launch FACSCComp to run calibration again.
 - If you launched BD FACSCComp software within Worklist Manager software, the FACSCComp view in Worklist Manager software appears, stating that both calibrations were successful. Click Continue on the button panel to advance to the Worklist view in Worklist Manager software.

Entering Sample Information

You must enter sample information whether the Data Source is From Cytometer (acquisition) or From Data Files (analysis only), but you cannot mix acquisition and analysis entries in the same Schedule document. This section describes how to enter sample information for acquisition; for analysis only, see page 146.

- 1 Click in the first required field, and enter information.

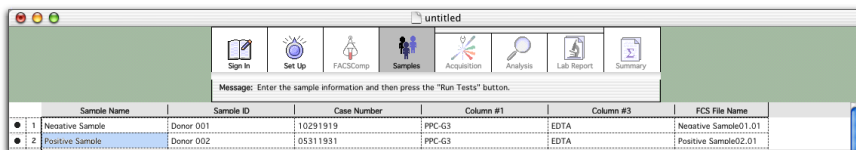

At the minimum, enter information for the file name prefix selected in the Set Up view. The message box shows which fields are required. Enter information by typing, or use a barcode scanner.

- 2 Choose File > Save to save the Schedule document.

Acquiring Data

At the Acquisition view, sample data is shown in plots before and during acquisition. Data is not saved until you click Acquire. Once a sample has been run on the cytometer, sample information in the Samples view cannot be edited.

- 1 On the cytometer, press RUN and HI.
- 2 Vortex and install the first sample tube on the SIP.

Make sure the run order corresponds with the Samples view. For acquisition with the Loader, see Chapter 6.

- 3 Click Run Tests at the Samples view.

BD HLA-B27 instrument settings are automatically sent to the cytometer. The Acquisition view appears and events appear in the plots.

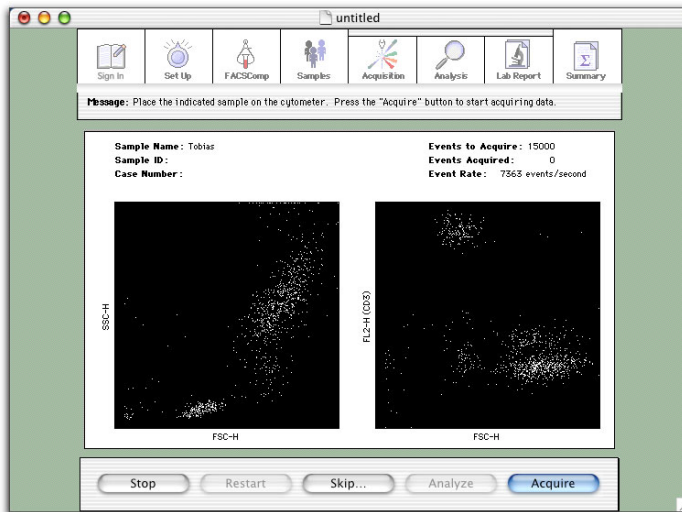

- 4 Click Acquire.

Acquisition proceeds until the designated number of events is acquired.

The software proceeds with acquisition and analysis of the next tube.

After the last tube is run, review the Summary Report.

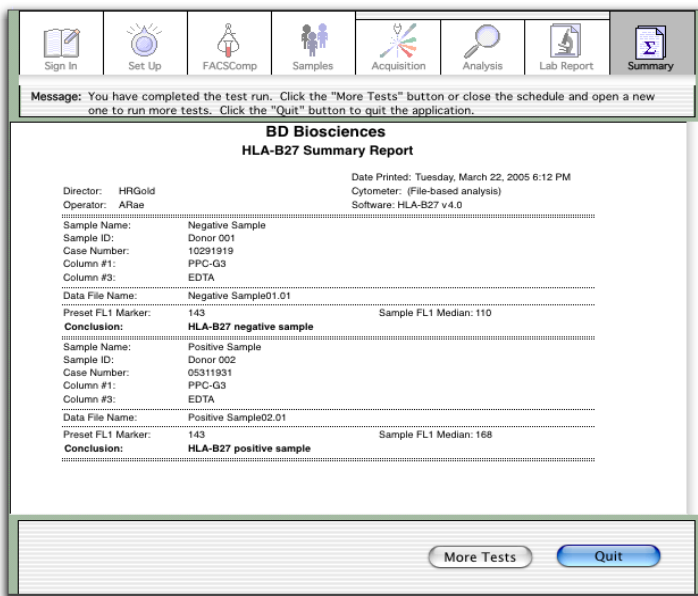

9 Click Quit.

10 Install a tube of DI water on the SIP, and press STNDBY.

Analyzing Data

BD HLA-B27 software can analyze only FCS 2.0 data files acquired in BD HLA-B27 software. Use BD FACS Convert software to translate files created by HP HLA-B27 software to FCS 2.0.

NOTICE You cannot mix cytometer-based entries with data file-based entries in the same Schedule document. During set up, select *From Data Files* as the Data Source in the Set Up view.

- 1 From the Samples view, click Add Samples.



- 2 Choose files for analysis.

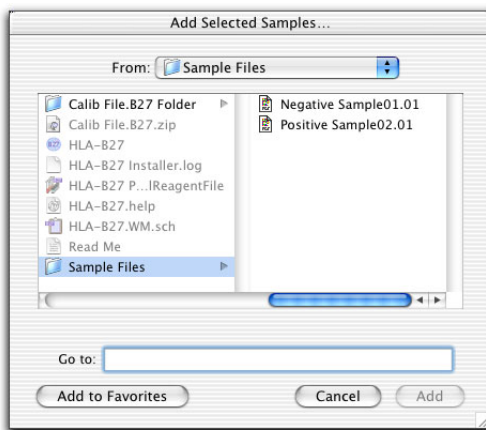

- Navigate to the required folder.
- Double-click an individual file, or select multiple files and click Add.

The Samples view appears, listing all selected files.

- 3 Click Run Tests.

The Acquisition view appears briefly while data is read from the file, and the Lab Report view displays.

- 4 Review the Lab Report, and click Next.
- 5 When all files have been analyzed, review the Summary Report, and click Quit.

6

Running Samples with the Loader

Before you begin, start up the cytometer (page 55), perform instrument QC (page 61) and optimize settings for samples to be run (page 79).

- Preparing an Acquisition Document on page 150
- Setting Up BD Worklist Manager Software on page 151
- Entering Sample Information on page 156
- Running Samples on page 160

Preparing an Acquisition Document

For acquisition, Worklist Manager requires access to an application-specific document with defined acquisition conditions. When you click Run Tests at the Worklist view, Worklist Manager uses the defined document to launch the acquisition software.



BD CellQuest Pro

- 1 Define an Experiment document with appropriate Acquisition & Storage conditions.
 - Use Acquisition-to-Analysis plots to print data after each tube is acquired
 - For Collection Criteria, use *Event Count* or *Time* to ensure you will not run out of sample.
- 2 Define a panel.
- 3 Select the panel in the Acquisition Browser.
- 4 Save the document in BD Applications > Worklist Manager > CellQuest Experiments Folder.



BD Multiset

- 1 Use the default Schedule document or define a Schedule document with choices from Test Prefs.

NOTICE For absolute counts, do not mix lots of BD Trucount tubes in the same worklist. Make sure the BD Trucount bead information in the Schedule document is correct before you run it with Worklist Manager software.
- 2 Customize Preferences.
- 3 Save the document where you want.



BD HLA-B27

- 1 Use the default Schedule document or define a Schedule document with your preferred number of events to acquire.
 - 2 Customize Preferences.
 - 3 Save the document where you want.
-

Setting Up BD Worklist Manager Software

- 1 Launch BD Worklist Manager software: 

NOTICE Worklist Manager will not launch if other BD applications are running, and other BD applications cannot be launched independently while Worklist Manager is running.

Along with Worklist Manager, BD Loader Manager software launches and checks that the Loader is connected.

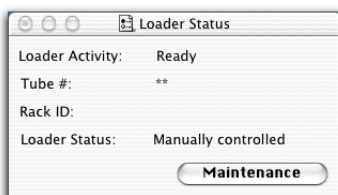

- 2 At the Sign In view, enter at least the Operator name and click Accept.

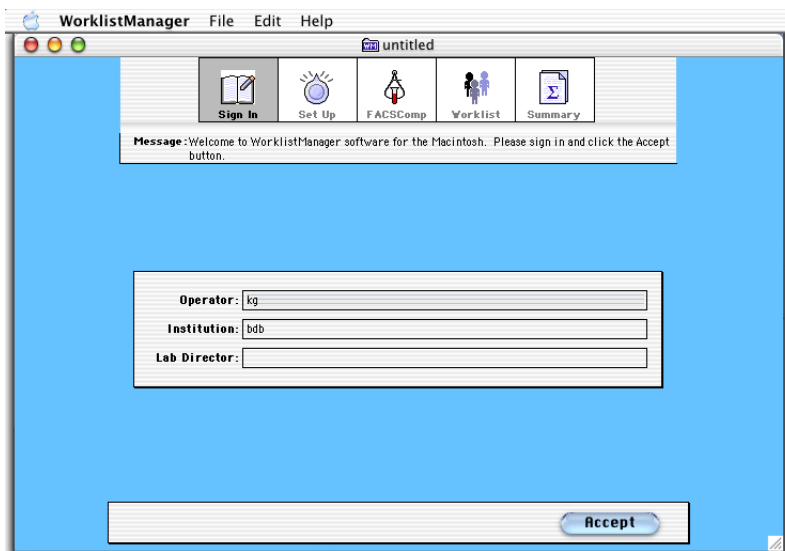

- 3 At the Set Up view, select a File Name Prefix for data files.

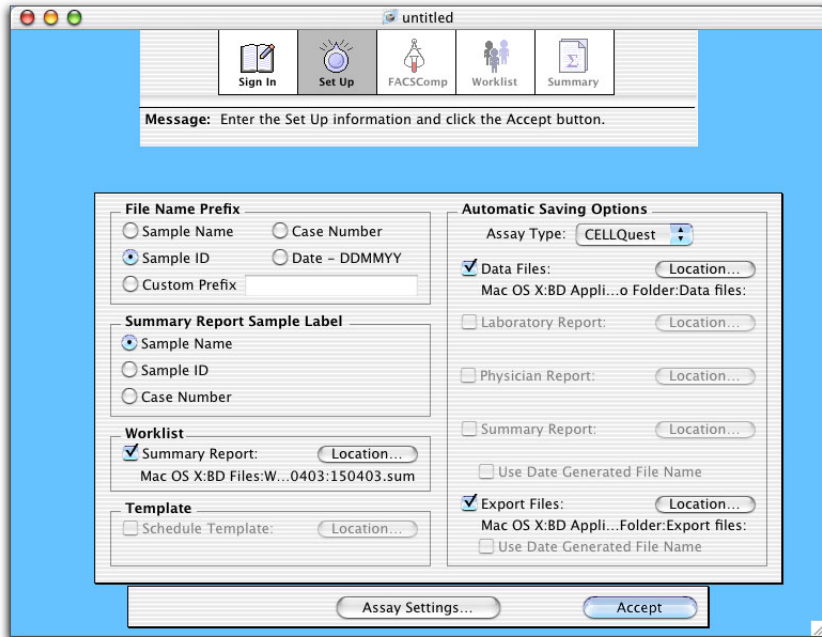

- For Sample Name, Sample ID, or Case Number, make entries in the corresponding column of the Worklist view.
- For Custom, enter a prefix in the box.

- 4 Under Summary Report Sample Label, select a label for samples on the Summary Report.

To save a Summary Report file, ensure the Summary Report checkbox is selected under Worklist. Click the Location button to change the default name or storage location.

- 5 For BD Multiset or HLA-B27 assays, select the Schedule Template checkbox.

Make sure your Schedule document template is in the indicated location. To change, click Location, and select your template in the dialog that appears.

- 6 Under Automatic Saving Options, choose the Assay Type.
 - 7 Click the checkbox for each file you want to save; click Location to change the default name or storage location.
- Tip** For Export Documents, append data by selecting an existing file in the Choose Location dialog.

Setting Up Assay Settings

Use Assay Settings to associate instrument settings with a panel, customize mix settings, and specify whether to print plots in BD CellQuest Pro software.

- 1 Click Assay Settings in the Set Up view.
- 2 Select an assay icon (CELLQuest, MultiSET, HLA-B27).

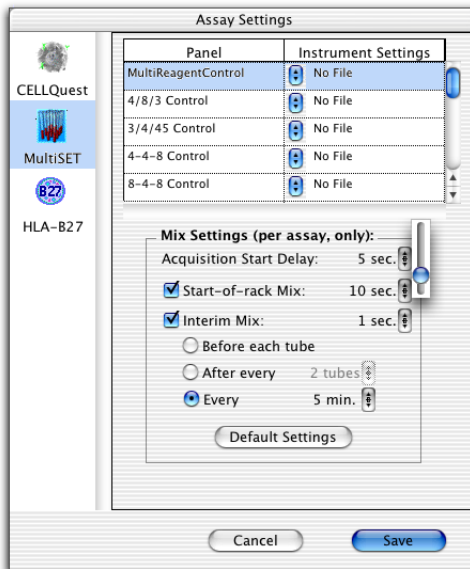

- For BD CellQuest Pro assays, all panels from Experiment documents in BD Applications > Worklist Manager > CellQuest Experiments folder are shown (*Panel name : Experiment document name*).

Panel	Instrument Settings
IMK Lymph : KG doc	No File
Loader Test : Loader Test	No File
IMK Lymph : Simple exp...	No File

- For BD Multiset assays, all defined panels are shown.
- For HLA-B27 assays, one panel is shown.

3 Click the pop-up control next to each panel, and choose the appropriate file.

All instrument settings files in BD Files > Instrument Settings Files are shown.

Panel	Instrument Settings
MultiReagentControl	No File
4/8/3 Control	BD CBA Calib File.LNW
3/4/45 Control	Calib File
4-4-8 Control	Calib File.B27
8-4-8 Control	Calib File.LNW
	LeucoCOUNT Calib File.LNW
	MultiTEST.opt
	TriTEST.opt

4 Adjust Mix Settings, if needed.

- For BD CellQuest Pro assays, mix settings are panel-specific. Each time you run that panel, assigned settings are used. Default settings are appropriate for immunophenotyping.
- For BD Multiset and HLA-B27 assays, mix settings are common to all panels.

5 (Optional) For BD CellQuest Pro assays, select the *Print CELLQuest Plots* checkbox.

This feature is useful if your Experiment document has acquisition-to-analysis plots and displays the appropriate statistics. If only acquisition

plots are defined, printed statistics reflect the last events acquired, not the entire data file.

Tip If you have tube-specific plots in your Experiment document, only the final printout will contain a complete set of data. To save paper, deselect the checkbox and print the analysis only after all tubes have been acquired.

6 Click Save in Assay Settings.

7 If the following message appears, review it and click OK.

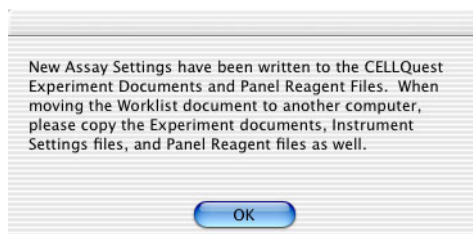

Running BD FACSComp Software

1 Click Accept at the Set Up view.

2 At the FACSComp view, click Skip FACSComp if you already ran setup for this run, or click Launch FACSComp.

- To run BD FACSComp with the Loader, see page 66. Manually quit when setup is complete.
- Click Continue to proceed to the Worklist view.

Saving the Worklist

Before you enter sample information, save the worklist with information entered so far. The file can be used as a template for starting your daily worklist.

Tip Once saved, make the worklist a stationery pad or locked document. When you open a worklist that is a stationery pad, a copy of the original opens. A locked

document prevents the original worklist from being accidentally overwritten. Refer to Mac Help for instructions.

- 1 Choose File > Save.
- 2 Enter a name for the file and choose a storage location.

Entering Sample Information

At the Worklist view, enter sample information for up to 99 samples.

- 1 Enter information in one of the first 3 columns of the Worklist.

At the minimum, enter information for the file name prefix selected in the Set Up view.

You can manually enter information, scan from a barcode label, or choose File > Import Worklist to import information from a tab-delimited file or a worklist created with BD FACSTM Sample Prep Assistant (SPA) software.

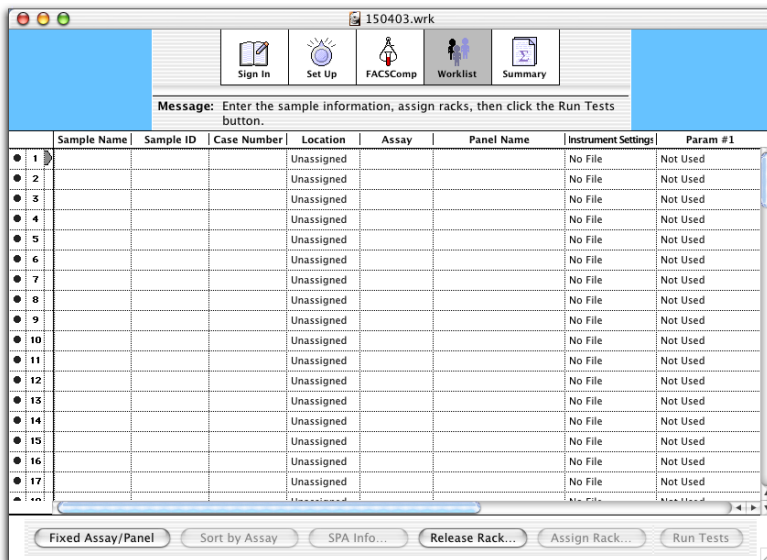

- 2 Assign an assay and panel to each sample, or assign a fixed assay or panel to all samples.
 - To assign individual samples, click in the Assay and Panel Name columns and choose options from the drop-down menus.
 - To assign all samples, click Fixed Assay/Panel and select an option for Mode (Fixed Assay, Fixed Panel, Fixed Assay and Panel, or Flexible). For fixed assay or panel, choose the Assay or Panel you would like to appear by default, and click OK.

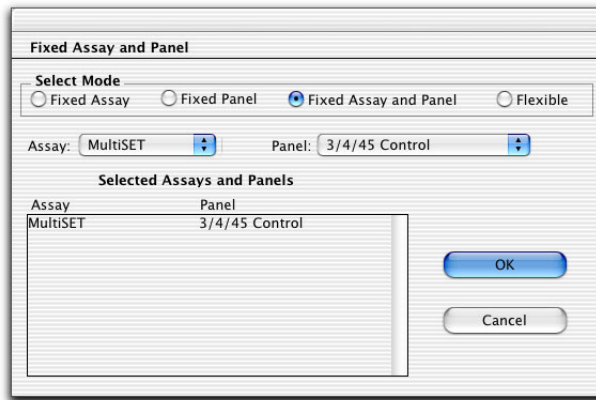



- 3 Verify the instrument settings file for each sample.

To change the associated file, go to Assay Settings at the Set Up view.

- 4 Click Sort by Assay when running multiple assays.

Tip BD Biosciences recommends that you group like assays together for multiple assays in the same Worklist.

- 5 Use status icons next to the entry numbers to verify that all information was entered:

	File Name Prefix not entered, or Assay and Panel Name not defined
	File Name Prefix, Assay, and Panel Name entered, ready for rack assignment
	Information complete, tube location and rack ID defined, ready to run

- 6 Save the Worklist document.

Assigning Racks

Each tube in a worklist must be assigned to a rack location. Tube positions are assigned to samples according to their order in the Worklist view, and are filled in an unbroken sequence.

All the tubes from a sample's panel must reside on one rack; they cannot be split between two racks. Positions 39 and 40 are usually reserved for bleach and DI water tubes. These are used for cleaning between assays and at the end of a Worklist run.

- 1 Click Assign Rack at the Worklist view.

The Assign Racks dialog shows suggested tube positions for the first sample.

- 2 Select a sample in the Sample list to view tube rack locations.

Tubes associated with the sample are highlighted, and the reagents for each tube are shown in a scrollable list (Figure 6-1).

- 3 If you have more than 40 tubes, insert or move rack breaks.

Figure 6-1 Assigning racks

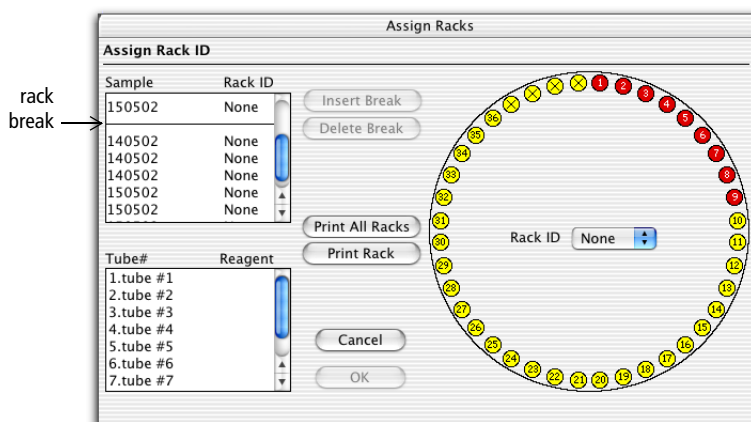

NOTICE Different BD CellQuest Pro panels can be associated with different mix settings. BD Biosciences recommends that you consider mix settings when you group samples from different panels on the same rack.

4 Choose a Rack ID.

Rack IDs are printed on top of each rack and on a label inside the rack which can be read optically by the Loader.

After a rack ID is assigned, entries in the Location, Assay, and Panel Name columns cannot be changed, and rack breaks cannot be inserted or deleted.

5 Print the Rack Manifest report, and click OK.

Click Print Rack to print a report for the current rack; click Print All Racks to print reports for all assigned racks. The Rack Manifest contains sample information, reagent names, and tube locations as well as a rack diagram with the entry numbers for each sample.

6 To edit rack assignments, click Release Rack.

Use the Release Rack dialog to edit entries after racks have been assigned or to reassign racks.

Running Samples

- 1 Gently vortex each sample tube and place it in the rack according to the Rack Manifest.

If cleaning tubes are required, install a tube containing 3 mL of 10% bleach in position 39 and a tube containing 3 mL of DI water in position 40.



For accurate results, make sure the tube loading sequence matches what is printed on the Rack Manifest.

NOTICE If loaded racks sit a long time before the samples are run, vortex the tubes again before proceeding.

- 2 Install the rack on the Loader.

Position the spindle hole over the center spindle of the Loader drawer, rotate the rack until the alignment guide pin fits into the small hole on top of the rack, and press down firmly.

Figure 6-2 Installing the Loader rack

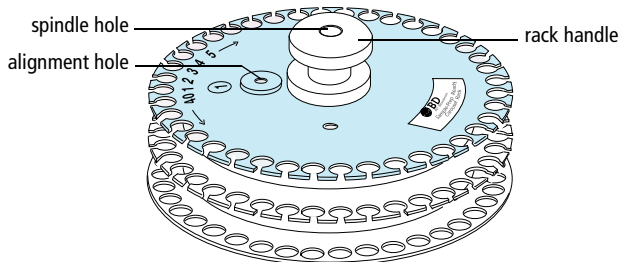

- 3 Close the Loader drawer completely, and install the Loader cover.

The Loader scans and positions the rack at tube Position 1.



To operate the Loader, the cover must be in place on the Loader drawer. Tubes will not be loaded if the cover is off, and currently running tubes will be unloaded if the cover is removed during a run.

4 Press RUN and the appropriate flow rate button.

Tip Before proceeding with the next step, make sure the printer paper tray has sufficient paper. If the printer runs out of paper in the middle of a run, the run will stop.

5 Click Run Tests.

Acquisition begins. If the Worklist contains different assay types, a short cleaning cycle runs between assays. When the Worklist is finished, a longer cleaning cycle runs.

NOTICE If an error occurs, a dialog appears with options to Retry, Continue, or Stop Run. Click Retry to recheck the status; click Continue to finish acquisition of the tube without fixing the error. Errors are shown on the Summary Report.

6 If prompted, enter or scan the carousel ID for an imported SPA Worklist, and click Continue.

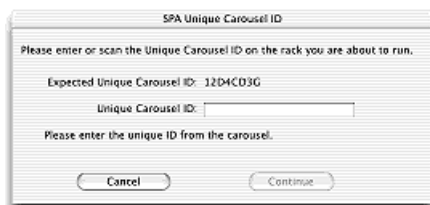

7 Install the next rack when prompted, if running more than 40 tubes.

8 Review sample status on the Summary Report.

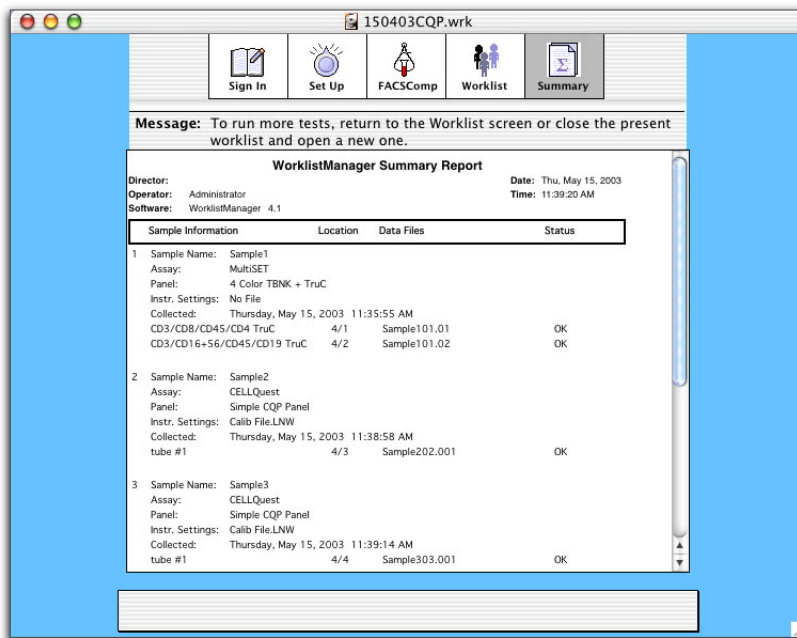

For BD Multiset errors, see page 200; for other errors, see page 208.

- 9 Remove the Loader cover, pull out the Loader drawer, and remove the rack.
- 10 Install a tube of distilled water on the SIP, and press STNDBY.
- 11 Quit BD Worklist Manager software.

Pausing Acquisition

NOTICE To interrupt the Loader during a BD Multiset assay, pause in the BD Multiset Acquisition or Lab Report view. Do not use Worklist Manager to stop a BD Multiset run; do not stop by removing the Loader cover.

NOTICE After an aborted run, the long clean is not performed automatically. You will then have to run cleaning manually (page 166).



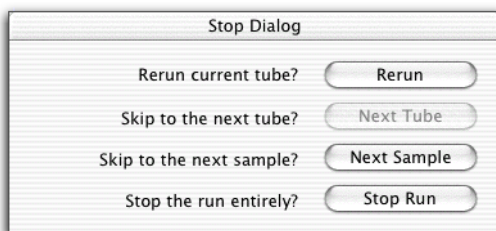

Do the following to stop the Loader during a BD CellQuest Pro assay.

- 1 Click Stop at the Worklist view.
- 2 When the countdown dialog appears, click Yes.
- 3 Choose from the following:



- Rerun—reruns the current tube
- Next Tube—skips to the next tube on the Worklist
- Next Sample—advances the Loader to the first tube of the next sample (if available), leaving the previous sample incomplete
- Stop Run—advances to the Summary Report view

Worklist status icons show which samples have been run.

	Ready to run
	Running test
	Sample acquired
	Error during acquisition

Rerunning a Sample

You can perform up to 5 full-panel reruns when a Worklist is finished or completely stopped. You must start the rerun from the Worklist view. Starting with *a*, Worklist Manager adds a lowercase letter to the filename, after the entry number for a full-panel rerun or after the tube number for a single-tube rerun.

- 1 Click the Status icon of the sample you want to rerun.
- 2 Click Rerun to rerun the entire panel.

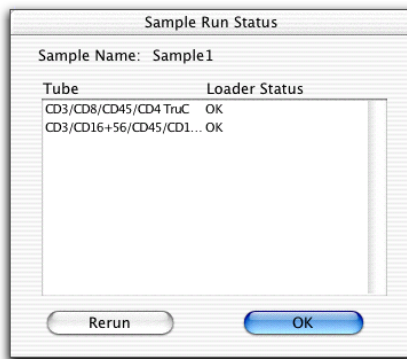

NOTICE You cannot rerun individual tubes. To cancel, click OK.

Shutting Down

To ensure consistent instrument functioning, always clean the instrument before you turn it off at the end of the day.

Do the following before instrument shutdown and immediately after running viscous samples or dyes such as propidium iodide (PI), acridine orange, or thiazole orange.

Tip If you will not be using your instrument for a week or longer, decontaminate the fluidics (page 171) and keep DI water in the fluidics system until you use the instrument again.

- 1** Install a tube containing 3 mL of cleaning solution.

For cleaning, use BD FACS Clean, a 1:10 dilution of bleach in DI water, or 0.5% sodium hypochlorite.

- 2** Move the support arm to the side and allow the vacuum to aspirate 2 mL of the solution.
- 3** Move the support arm to the center and run the cleaning solution on HI for 5 minutes.
- 4** Install a tube containing 3 mL distilled (DI) water.

- 5 Move the tube support arm to the side and allow the vacuum to aspirate 2 mL of DI water.
- 6 Move the support arm to the center and run the DI water on HI for 5 minutes.
- 7 Leave the tube containing no more than 1 mL of DI water on the SIP.
- 8 Press STANDBY.

NOTICE To allow the laser to cool down, leave the instrument in STANDBY for 5 minutes before you turn off the power.
- 9 Exit the software.
- 10 Turn off the instrument.
- 11 Shut down the computer.

Daily Shutdown with the Loader

A Long Clean is performed automatically at the end of each Worklist run. Do the following when you stop a Worklist prematurely, or for additional optional cleaning after an automatic clean. To skip cleaning, begin shutdown with step 8.

- 1 Set up a Loader rack with cleaning tubes; install the rack on the Loader.

Install a 12 x 75-mm tube of 3 mL cleaning solution in position 39, and a tube of 3 mL DI water in position 40.
- 2 Install the Loader cover; press RUN.
- 3 Quit Worklist Manager, if running.
- 4 Launch Loader Manager software: 

- 5 Click Maintenance.

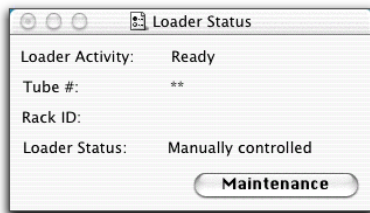

- 6 Verify Long Clean is selected; click Run.

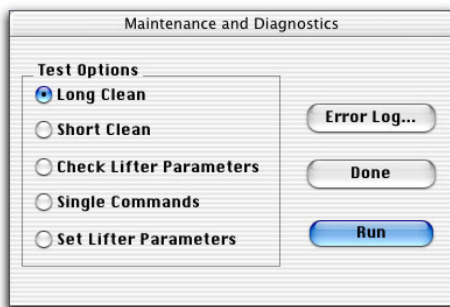

- 7 At the prompt, click Run again.
- 8 When cleaning is complete, remove the Loader cover and rack.
- 9 Install a tube of DI water on the SIP, and press STNDBY.
- 10 Quit Loader Manager software.
- 11 Turn off the instrument and the Loader.
- 12 Push in the Loader drawer; leave the Loader rack and cover off.
- 13 Shut down the computer.

Maintenance

- Scheduled Maintenance on page 170
- Unscheduled Maintenance on page 175
- Loader Maintenance on page 179



Any instrument surface that comes in contact with biological specimens can transmit potentially fatal disease. Use universal precautions when cleaning the instrument or replacing parts. Wear suitable protective clothing, eyewear, and gloves.

Cleaning Solution

For cleaning, use one of the following:

- BD FACS Clean (For ordering information, see page 215.)
- 10% bleach (1:10 dilution of household bleach in DI water)
- 0.5% sodium hypochlorite



Higher concentrations of sodium hypochlorite and other cleaning agents can damage the instrument.

Scheduled Maintenance

Maintenance Procedure	Description and Location	Frequency
Filling the sheath	page 56	Daily and as needed
Emptying the waste	page 58	Daily and as needed
Daily shutdown	page 165	Daily and immediately after running viscous samples or dyes such as propidium iodide (PI), acridine orange, or thiazole orange.
Cleaning the fluidics	Decontaminates the sheath tubing, waste tubing, and flow cell with cleaning solution, then rinses with DI water. See page 171.	Monthly and before service calls
Replacing the sheath filter	Keeps fluids free of particulates See page 173.	Every 3–6 months or when increased debris seen in FSC vs SSC plots
Scheduling preventive maintenance by a qualified service engineer	—	Every 6 months

Decontaminating the Fluidics

Perform overall system fluidics cleaning once a month or more frequently if you are running high volumes of samples stained with propidium iodide (PI), acridine orange, or thiazole orange. You need a spare reservoir for this procedure. See Appendix A, Supplies and Replacement Parts.

- 1 Remove the sheath reservoir.

See Filling the Sheath Reservoir on page 56.
- 2 Disconnect the sheath filter tubing from the SALINE FILTER port.
- 3 Install a spare reservoir containing 1–2 L of cleaning solution.

See page 169 for options.
- 4 Connect the sheath tubing (white) from the spare reservoir to the SALINE FILTER port.

Figure 8-1 Bypassing the sheath filter

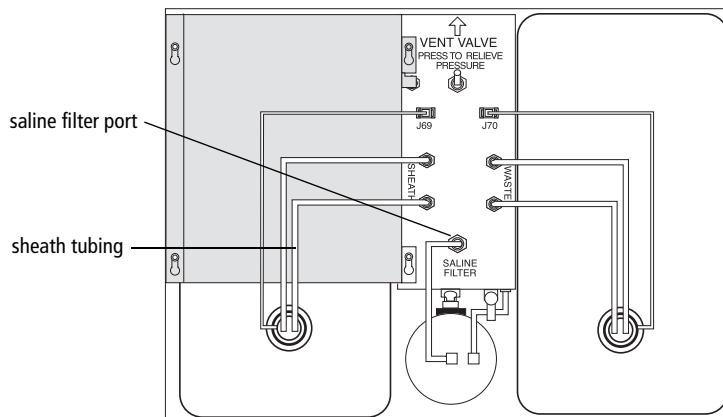

This bypasses the sheath filter, allowing sheath fluid to travel directly to the flow cell, then to the waste reservoir.



Do not run bleach or detergent through the sheath filter. This can break down the filter paper within the filter, requiring filter replacement and resulting in paper fragments that could clog the flow cell.

- 5** Pull the vent valve toward you to repressurize.
 - 6** Install a tube containing 3 mL of cleaning solution on the SIP.
 - 7** Run the cleaning solution on HI for 20–30 minutes.
 - 8** Replace the cleaning solution reservoir with a reservoir containing DI water.
 - 9** Install a tube containing 3 mL of DI water on the SIP, and run the DI water on HI for 20–30 minutes.
- Tip** If you will not be using your instrument for a week or longer, keep DI water in the fluidics system until you use the instrument again.
- 10** Replace the DI water reservoir with the original sheath reservoir, and reconnect the sheath filter.
 - 11** Ensure the tube on the SIP has 1 mL of DI water, and press STNDBY.
 - 12** Turn off the instrument if you are finished running samples.

Changing the Sheath Filter

The sheath filter traps debris before it reaches the flow cell. Replace the filter every 3–6 months or when you see increased debris in an FSC vs SSC plot.

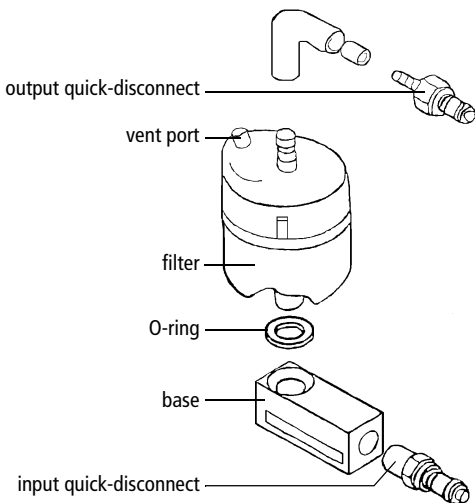

- 1** Open the fluidics drawer.
- 2** Push the vent valve toward the arrow to depressurize the system.
- 3** Disconnect the output and input quick-disconnects.
- 4** Unscrew the air vent tubing fitting from the filter vent port.

Ensure the filter is free of the instrument and the air vent tubing is attached to the instrument.

- 5** Unscrew and remove the base from the filter body.

Save this piece to attach to the new filter.

- 6** Pull the output tubing from the output port.

Save the tubing to attach to the new filter.



Use caution when pulling the tubing from the port. Depending on the force with which you pull off the tubing, drops of sheath fluid can splatter. To catch drops, cover the tubing and output port with a paper towel.

7 Discard the old filter.

8 Install a new O-ring around the threads at the bottom of the new filter.

Push the O-ring as far up to the threads as possible.

Tip Wrap teflon tape around the threads to provide a better fit.

9 Attach the base (from step 5) to the new filter and turn it until snug.

10 Attach the output tubing (from step 6) to the new filter by pushing the tubing onto the output port.

11 Place the filter in the fluidics drawer with the base at the bottom and the output port at the top.

12 Reconnect the output and input quick-disconnects.

13 Screw the air vent tubing fitting (from step 4) to the new filter's vent port.

14 Pull the vent valve forward to repressurize the system.

15 Fill the newly installed filter with fluid.

Push RUN and push the pinchcock roller forward to allow air to escape as the filter fills with fluid. Close the pinchcock roller when the filter is filled.

If you see bubbles, gently tap the filter body to dislodge bubbles and force them to the top. Push the pinchcock roller forward to force the bubbles to waste. Close the pinchcock. Repeat, if necessary.

16 Write the replacement date on the outside of the filter.

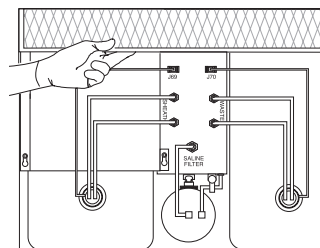

Unscheduled Maintenance

Maintenance Procedure	Description	When to Perform
Cleaning external surfaces	<p>Keeps surfaces free from salt buildup</p> <ol style="list-style-type: none"> 1 Dampen a cloth with cleaning solution (page 169) and wipe dried sheath fluid from surfaces. 2 Wet a fresh cloth with DI water and wipe surfaces to prevent bleach corrosion. 3 Wipe surfaces with a clean, dry cloth. 	Whenever needed
Cleaning the air filter	<p>Removes dust and debris impeding air flow</p> <ol style="list-style-type: none"> 1 Turn off power; open fluidics drawer. 2 Grasp filter edges and pull gently to slide out. 3 Vacuum the filter or hold it under running tap water to clean. Allow it to dry completely before reinstalling. 4 Reinstall the filter, ensuring arrows on edge of filter point up. Align right edge against spring clips in slide rail, and push forward slowly. 5 Close the fluidics drawer. 	Inspect periodically and clean when dirty
Priming the fluidics	<p>Removes bubbles from flow cell</p> <p>See page 58.</p>	When needed during daily startup
Replacing the Bal Seal	<p>Replaces worn Bal seal</p> <p>See page 176.</p>	When seal becomes worn or cracked or sample tubes will not pressurize
Replacing the sample O-ring	<p>Replaces worn sample O-ring</p> <p>See page 178.</p>	When droplets form at the end of the SIT when the droplet containment vacuum is operating



Changing the Bal Seal

The Bal seal is a Teflon ring that forms a seal with the sample tube enabling proper tube pressurization. Over time, this seal becomes worn or cracked and requires replacement. Replacement is necessary if a proper seal is not formed when a sample tube is installed on the SIP.

  Any instrument surface that comes in contact with biological specimens can transmit potentially fatal disease. Use universal precautions when cleaning the instrument or replacing parts. Wear suitable protective clothing, eyewear, and gloves.

- 1 Remove the outer sleeve from the SIT by turning the retainer counterclockwise.

Figure 8-2 Removing outer sleeve

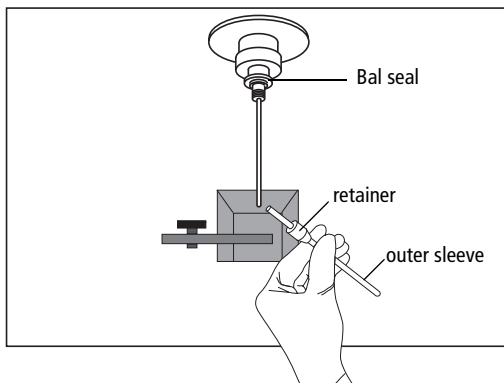

Work carefully since the outer sleeve can fall out as you loosen the retainer.

-
- 2** Grip the Bal seal between your thumb and index finger and pull it off.

Figure 8-3 Removing Bal seal

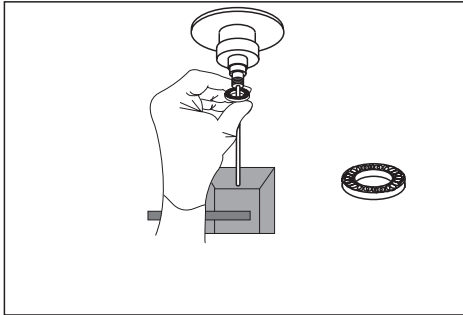

-
-
- 3** Install the new Bal seal spring-side up, just above the threads for the SIP retainer.
- 4** Reinstall the retainer and outer sleeve.

Tighten the retainer enough to hold it in place, and slide the outer sleeve over the SIT, into the retainer opening. Push the sleeve up as far as it goes as you continue tightening the retainer.

-
-
-
-
- 5** Gently push the seal in place to seat it.

If the seal does not remain in position when you let go, hold it with one hand while you reinstall the retainer. The seal seats as you screw on the retainer.

-
-
-
-
-
- 6** Install a sample tube on the SIP.

If the sleeve hits the bottom of the tube, loosen the retainer slightly, and push the sleeve up. Retighten the retainer.

Changing the Sample O-ring

The sample tube O-ring is located within the outer sleeve retainer. It forms a seal that allows the droplet containment vacuum to function properly. Replace the O-ring when droplets form at the end of the SIT while the vacuum is operating.



Any instrument surface that comes in contact with biological specimens can transmit potentially fatal disease. Use universal precautions when cleaning the instrument or replacing parts. Wear suitable protective clothing, eyewear, and gloves.

- 1** Remove the outer sleeve from the SIT.

See Figure 8-2 on page 176.

- 2** Invert the retainer and tap out the O-ring.

- 3** Drop a new O-ring into the retainer.

Make sure the O-ring is seated properly in the bottom of the retainer.

- 4** Reinstall the retainer and the outer sleeve.

Tighten the retainer enough to hold it in place, and slide the outer sleeve over the SIT, into the retainer opening. Push the sleeve up as far as it goes as you continue tightening the retainer.

- 5** Install a sample tube on the SIP.

If the sleeve hits the bottom of the tube, loosen the retainer slightly, and push the sleeve up. Retighten the retainer.

Loader Maintenance

Maintenance Procedure	Description	When to Perform
Running a Long Clean	Runs cleaning solution, then DI water for approximately 12 minutes See page 166.	When Worklist is stopped before finished, or for additional optional cleaning
Checking tube lifter calibration	Displays lifter parameters See page 180.	When needed for Loader diagnostics or troubleshooting
Verifying connection ports	See page 181.	When communication errors observed
Replacing the Loader seal	See page 182.	When tube pressurization issues occur (Change the seal only after trying all other solutions on page 208.)
Cleaning the tube lifter	See page 184.	To correct a repeated vertical timeout error
Modifying the cytometer for non-Loader use	See page 186.	To use the cytometer without the Loader

Checking Tube Lifter Calibration

Tube lifter parameters are used to adjust the tube lifter to ensure proper sealing with the SIP. You might be asked to locate these settings for BD Biosciences personnel during troubleshooting.

- 1 Quit Worklist Manager, if running, and launch Loader Manager.
- 2 Click Maintenance.

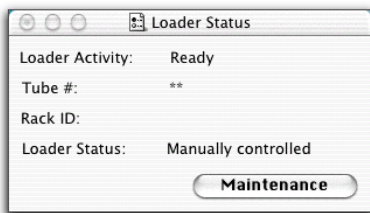

- 3 In Maintenance and Diagnostics, select Check Lifter Parameters, and click Run. Parameters show in a separate window:

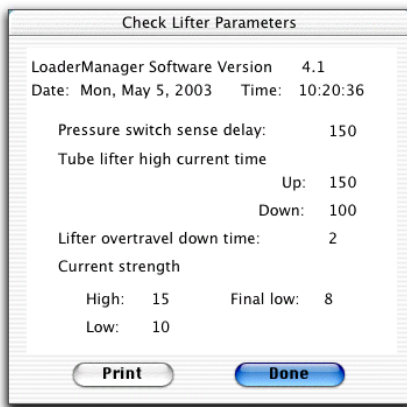

- 4 (Optional) Click Print.
- 5 Click Done, Done, and close the Loader Status window.

Verifying Connection Ports

The Loader electronics module connects to the computer via a Keyspan USB-to-serial adapter. If communication problems exist between the Loader and cytometer, check cable connections and ensure the correct port is selected in Loader Manager Preferences.

- 1 Remove the back access cover from the cytometer; check cable connections between the Loader electronics module and the adapter (Figure 8-4).

NOTICE For Mac OS X computers, the cable should be attached only to adapter **port 2** (curved side of adapter).

Figure 8-4 Loader to computer connections

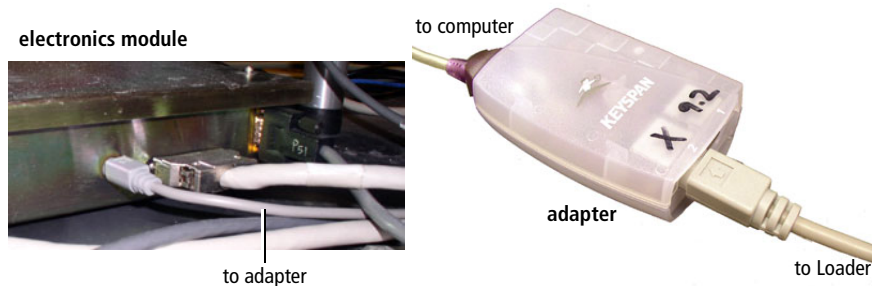

- 2 Check cable connections between the adapter and the computer.
- Tip** For reliable performance, plug the adapter directly into a USB port on the computer; do not use a USB hub.
- 3 Quit Worklist Manager, if running, and launch Loader Manager.
 - 4 Choose Loader Manager > Preferences.

- 5 Verify Print Port (2) is selected; click Save.

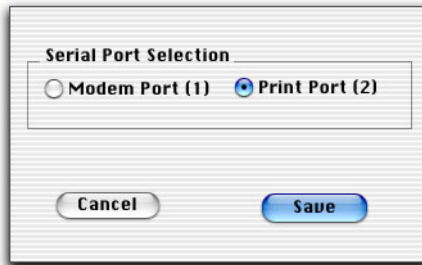

If you continue to have connectivity problems after checking all cable connections, contact your BD Biosciences service representative.

Replacing the Loader Seal

The Loader seal can become worn over time and need replacement. If you have trouble with tube pressurization errors, first see page 208. If no other solutions work, replace the seal.



Any instrument surface that comes in contact with biological specimens can transmit potentially fatal disease. Use universal precautions when cleaning the instrument or replacing parts. Wear suitable protective clothing, eyewear, and gloves.

- 1 Turn off the instrument main power.
- 2 Remove the tube guide retainer and attached tube guide.

Turn the tube guide and retainer counterclockwise, as shown in Figure 8-5.

Figure 8-5 Removing tube guide retainer

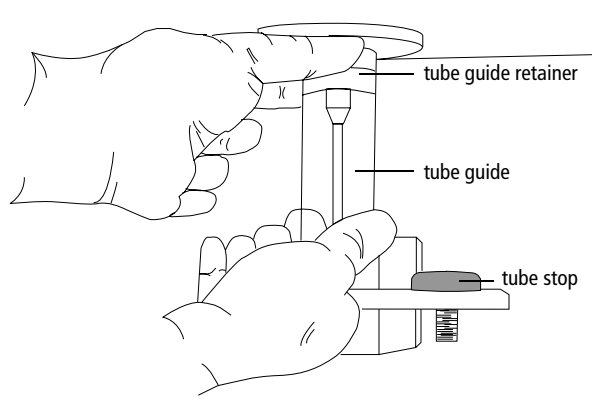

- 3** Remove the outer droplet sleeve from the SIT by turning the SIP retainer counterclockwise.

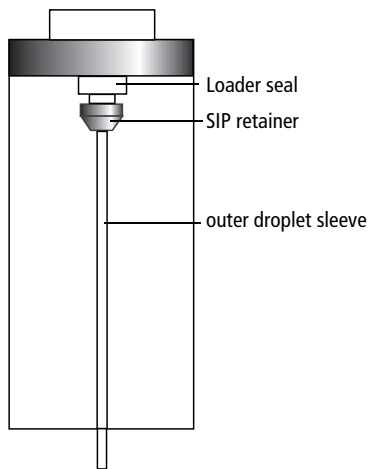

- Tip** Hold the sleeve as you turn the retainer. The outer sleeve might fall out as the retainer is loosened.
- 4** Remove the flat red or white Loader seal.

- 5 Install the new seal.

The Loader accessory kit includes 3 versions of the seal—thick, medium, and thin. Install the next-thickest version, compared to the seal that is currently installed. Make sure it is flush against the SIT.

For reordering information, see page 213.

- 6 Replace the outer droplet sleeve and tighten the SIP retainer.
- 7 Replace the tube guide retainer and the tube guide.
- 8 Turn on the instrument main power, and test the new seal by loading a tube with the Lifter key on the Loader keypad.

Cleaning the Tube Lifter

The Loader tube lifter might need cleaning if a vertical timeout error is reported by Loader Manager software. Use the Single Commands dialog to load a single tube so you can access the tube lifter.

- 1 Place an empty test tube in position 1 on a Loader rack, and install the rack on the Loader.
- 2 Push in the Loader drawer and replace the cover.
- 3 Confirm that all software applications are closed.
- 4 Launch Loader Manager, and click Maintenance.
- 5 Click Single Commands in the Maintenance and Diagnostics window, and click Run.

- 6 Select the Park lifter command in the left column, and click Send.

Ensure the tube number is 1 in the *Enter the tube number to load* field.

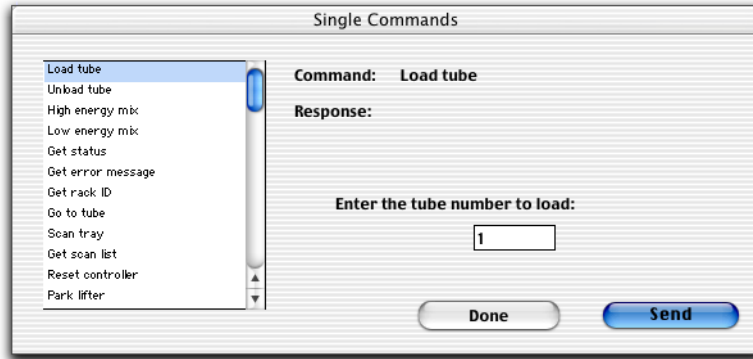



- 7 Once the lifter is raised, switch off the Loader power on the keypad.
 - 8 Remove the Loader cover.
 - 9 Hold the test tube with one hand while you pull out the Loader drawer with the other hand.
 - 10 Remove the Loader rack and test tube, and place the test tube in the rack.
 - 11 Use a gauze pad and DI water to wipe the tube lifter shaft and base.
 - 12 Push in the Loader drawer and replace the cover.
 - 13 Switch on the Loader power.
The lifter will automatically lower.
 - 14 Select the Reset controller command in the Single Commands dialog, and click Send.
 - 15 Install a rack with a tube in position 1 and check the tube lifting and sealing.
- Tip** Place the cytometer in RUN.

For other troubleshooting suggestions, see page 209.

Modifying the Cytometer for Non-Loader Use

When a Loader is installed, the Bal seal is removed and a Loader seal and tube guide are installed. This configuration creates the proper seal and pressurization for Loader use. To acquire samples without the Loader, you must remove the tube guide and replace the Bal seal.

  Any instrument surface that comes in contact with biological specimens can transmit potentially fatal disease. Use universal precautions when cleaning the instrument or replacing parts. Wear suitable protective clothing, eyewear, and gloves.

- 1 Turn off the instrument main power.
- 2 Remove the tube guide retainer and attached tube guide.

Turn the tube guide and tube guide retainer counterclockwise, as shown.

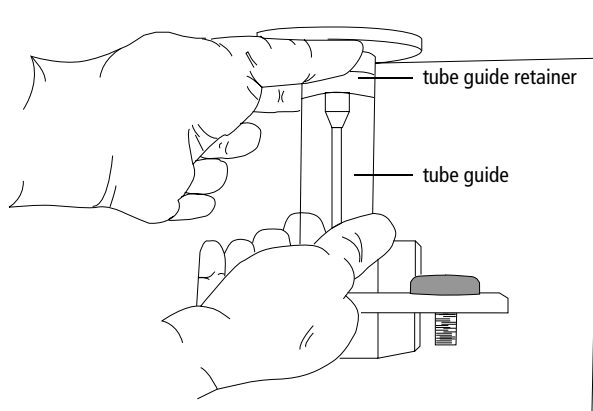

- 3 Remove the outer droplet sleeve from the SIT by turning the SIP retainer counterclockwise.

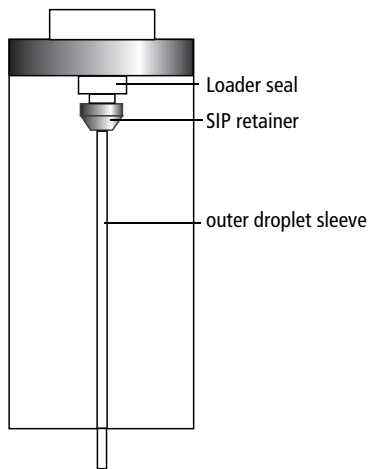

- Tip** Hold the sleeve as you turn the retainer. The outer sleeve might fall out as the retainer is loosened.

- 4 Remove the flat red or white Loader seal.
- 5 Install the black rubber O-ring in place of the Loader seal.

To order a replacement, see page 212.

- 6 Install the Bal seal, the SIP retainer, outer droplet sleeve, and tube guide retainer.

See steps 3 through 6 on page 177 for instructions.

Troubleshooting

If additional assistance is required, contact BD Biosciences. Have the following information available: product name, catalog number, serial number, error messages, details of recent performance.

For instrument support from within the US, call (877) 232-8995, prompt 2, 2. From within Canada, call (888) 259-0187. Outside the US and Canada, contact your local BD representative or distributor. Refer to our website, www.bdbiosciences.com, for up-to-date contact information.

- Instrument Troubleshooting on page 190
- Acquisition Troubleshooting on page 191
- BD FACSComp Troubleshooting on page 195
- BD Multiset Troubleshooting on page 200
- Loader Troubleshooting on page 208

Instrument Troubleshooting

Observation	Possible Causes	Recommended Solutions
Droplet containment vacuum not functioning	Worn O-ring in retainer	Replace the O-ring (page 178).
	Outer sleeve missing or not seated in retainer	<ol style="list-style-type: none"> 1 Loosen the retainer. 2 Push up the outer sleeve until fully seated. 3 Tighten the retainer.
	Waste line pinched, insufficient aspiration	Check the waste line.
Flow cell not filling	No sheath pressure	<ul style="list-style-type: none"> • Verify the vent valve is forward. • Tighten the sheath cap. • Check that all sheath connectors are securely attached. • Check for leaks or cracks in the sheath reservoir. Replace it, if needed. • Check the Status sample voltage, in RUN with test tube off (page 112).
	Empty sheath reservoir	Fill the sheath reservoir.
	Air in sheath filter	Vent air from the sheath filter. See page 57, step 14.
FL4-%FL3 compensation more than twice usual	Loose sheath cap	Tighten the sheath cap.
	Air in sheath filter	Vent air from the sheath filter. See page 57, step 14.
	Air bubble in flow cell	Prime the fluidics (page 58).
	Inaccurate timing between blue and red laser	Perform Time-Delay Calibration (page 72).

Acquisition Troubleshooting

Observation	Possible Causes	Recommended Solutions
No events displayed and Status = READY	Insufficient gain for threshold parameter	Increase the Amp Gain for the threshold parameter (page 90).
	Threshold too high	Lower the threshold.
	Threshold set to incorrect parameter	Set the threshold to the appropriate parameter for the application (usually FSC). See page 92.
	No sample in tube	Add sample or install new sample tube.
	Improperly mixed sample	Mix sample to suspend cells.
	Clogged SIT	<ul style="list-style-type: none"> • Remove the sample tube to allow backflushing. • If the clog persists, clean the SIT (page 165).
	Gated plot with no data in gate	Delete or move the gate.
	Plot type = Analysis	In the Inspector, change the Plot Type to Acquisition or Acquisition-to-Analysis.
	Worn Bal seal	Replace the Bal seal (page 176).
Communication failure between computer and instrument	<ol style="list-style-type: none"> 1 Turn off the computer and instrument. 2 Turn on the instrument, then the computer. 	
GPIO error: cannot read instrument status	<ol style="list-style-type: none"> 1 Turn off the computer and instrument. 2 Reseat the GPIO cable (Figure 1-10 on page 22). 3 Turn on the instrument, then the computer. 	

Acquisition Troubleshooting (continued)

Observation	Possible Causes	Recommended Solutions
Low sample event rate	Threshold too high	Lower the threshold.
	Insufficient gain for threshold parameter	Increase the Amp Gain for the threshold parameter (page 90).
	Improperly mixed sample	Mix sample to suspend cells.
	Sample too dilute	Concentrate the sample. If the flow rate is not critical to the application, set the flow rate to MED or HI.
	Clogged SIT	Run 10% bleach and warm DI water for 20 minutes, then DI water for 10 minutes.
Erratic event rate	Cracked sample tube	Replace the sample tube.
	Worn Bal seal	Replace the Bal seal (page 176).
	Partially blocked SIT	<ul style="list-style-type: none"> Remove the sample tube to allow backflushing. If the clog persists, clean the SIT (page 165).
	Contaminated sample	Prep the specimen again, making sure the tube is clean.

Acquisition Troubleshooting (continued)

Observation	Possible Causes	Recommended Solutions
Scatter parameters distorted	Incorrect instrument settings	Rerun BD FACSComp or optimize the settings (Chapter 4).
	Air bubble in flow cell	Prime the fluidics (page 58).
	Air in sheath filter	Vent air from the sheath filter. See page 57, step 14.
	Dirty flow cell	Perform monthly cleaning (page 171).
	Air leak at sheath reservoir	<ul style="list-style-type: none"> • Check the connectors on the sheath sensor and saline filter. • Check the Status sample voltage, in RUN with test tube off (page 112). If <10.2, replace the sheath tank, the cap, and then the gasket.
	Hypertonic buffers	Check the pH of buffers and fixative.

Acquisition Troubleshooting (continued)

Observation	Possible Causes	Recommended Solutions
High CVs	Air bubble in flow cell	Prime the fluidics (page 58).
	Sample flow rate on HI	Set the sample flow rate to LO or MED.
	Improper sheath pressure	<ul style="list-style-type: none"> • Ensure the sheath cap is tight and all connectors are secure. • Check for leaks or cracks in the sheath reservoir. Replace it, if needed. • Check the Status sample voltage, in RUN with test tube off (page 112).
	Dirty flow cell	Perform monthly cleaning (page 171).
	Questionable sample preparation	Verify sample preparation technique.
	Air in sheath filter	Vent air from the sheath filter. See page 57, step 14.
	Sample not diluted in same fluid as sheath	Dilute the sample in the same fluid as sheath. If you are running BD Calibrite beads, dilute them in BD FACSTFlow solution and use BD FACSTFlow for sheath.

BD FACSComp Troubleshooting

PMT Adjustment

Observation	Possible Causes	Recommended Solutions
Unable to set PMT voltages automatically	Event rate below 400	<ul style="list-style-type: none">• Mix tube.• Set the flow rate to HI.• Add beads to tube for which event rate appears low.
	75-second time limit surpassed	Adjust settings manually for PMTs without checkmarks (page 71, step 4).
	Air bubble in flow cell	Prime the fluidics (page 58).
	Dirty flow cell or partial clog	Perform monthly cleaning (page 171).
>100-volt difference in PMT voltages	Contaminated beads	Prepare new beads.
	Air bubble in flow cell	Prime the fluidics (page 58).
	Dirty flow cell or partial clog	Perform monthly cleaning (page 171).
	Incorrect APC bead lot ID	Enter the correct APC bead lot ID.
	New target values for beads	Verify new target values are correct.

PMT Adjustment (continued)

Observation	Possible Causes	Recommended Solutions
>100-volt difference in FL4 PMT voltage	Air bubble in flow cell	Prime the fluidics (page 58).
	Expired APC beads	Check the expiration date. Prepare new beads, if needed.
	Labeled beads other than APC in unlabeled tube	Prepare new unlabeled + APC beads. Rerun BD FACSComp.
	Incorrect target values	Contact BD Biosciences for the latest target values.
	Incorrect APC bead lot ID	Enter the correct APC bead lot ID.
APC beads not detected (4-color setup not performed)	No APC beads in first tube	Add APC beads.
	Insufficient number of APC beads	Gently invert the APC bead vial and add a drop to the tube.
	Red laser disabled	Ensure the FL4 option is selected in BDPAC (page 27).
	FL4 PMT voltage too high	Decrease the FL4 PMT voltage.
Different PMT voltages between runs	Some runs with the Loader and some without	Maintain consistency: run with or without the Loader each time. Always run samples using the same acquisition method as BD FACSComp.

Time Delay Setup^a

Observation	Possible Causes	Recommended Solutions
Time-delay calibration fails	Air bubble in flow cell	Prime the fluidics (page 58).
	Cracked sample tube or pressure leak from tube	Check the tube and seal; replace as needed (page 176).
	Low event rate for APC beads	<ul style="list-style-type: none"> • Mix tube. • Set the flow rate to HI. • Add APC beads to the unlabeled + APC bead tube.
	Loose sheath cap	Tighten the sheath cap.
	Empty sheath reservoir	Fill the sheath reservoir.
	Incorrect APC bead lot ID	Enter the correct APC bead lot ID.
	FL4 PMT set incorrectly	Adjust settings manually for PMTs without checkmarks (page 71, step 4).
	FSC signal < channel 160	Contact BD Biosciences.
	FL4 PMT mean channel changed by >5 channels after time-delay calibration	Rerun the software.
	Air in sheath filter	Vent air from the sheath filter. See page 57, step 14.
Decreased sheath pressure from loose cap or leaking reservoir	<ul style="list-style-type: none"> • Ensure the sheath cap is tight and all connectors are secure. • Check for leaks or cracks in the sheath reservoir. Replace it, if needed. • Check the Status sample voltage, in RUN with test tube off (page 112). 	

a. Applies only for 4-color setup for instruments with the FL4 option.

Fluorescence Compensation

Observation	Possible Causes	Recommended Solutions
Unable to set compensation automatically	Event rate below 400	<ul style="list-style-type: none"> • Mix tube. • Set the flow rate to HI. • Add beads to tube for which event rate appears low.
	75-second time limit surpassed	Adjust compensation manually (page 74, step 4).
	Old mixed beads	Prepare fresh mixed beads. Rerun the software.
Compensation >50%	Incorrect target values	Contact BD Biosciences for the latest target values.
	Air bubble in flow cell	Prime the fluidics (page 58).
	Old mixed beads	Prepare fresh mixed beads. Rerun the software.
Compensation >50% for FL3-%FL4 and/or FL4-%FL3	Air bubble in flow cell	Prime the fluidics (page 58).
	Decreased sheath pressure from loose cap or leaking reservoir	Tighten the sheath cap and check the reservoir for leaks. Rerun the software.
	Old mixed beads	Prepare fresh mixed beads. Rerun the software.
	Incorrect target values	Contact BD Biosciences for the latest target values.
	Red laser misaligned	Contact BD Biosciences.
Compensation results different than expected	Wrong beads for assay (ie, PerCP-Cy5.5 beads for LW assay)	Rerun the assay with the correct FL3 beads.

Sensitivity Test

Observation	Possible Causes	Recommended Solutions
FL1, FL2, FL3, FL4, SSC, or FSC failure	Incorrect bead lot ID(s)	Verify lot IDs in the Set Up view.

HLA-B27 Calibration

Observation	Possible Causes	Recommended Solutions
>100-volt difference in FL1 PMT voltage	Contaminated beads	Prepare new beads.
	Air bubble in flow cell	Prime the fluidics (page 58).
	Dirty flow cell or partial clog	Perform monthly cleaning (page 171).
	Incorrect HLA-B27 bead lot suffix	Enter correct bead lot ID and suffix.
Calibration failure	Incorrect HLA-B27 bead lot suffix	Enter correct bead lot ID and suffix.
	Incorrect calibration beads	Use only BD HLA-B27 calibration beads.

BD Multiset Troubleshooting

The following are the most common error codes that appear on Lab and Physician Reports when acquisition criteria are not met.

NOTICE When an error code is generated, BD Multiset software creates a *Bad Files* folder within the folders for Lab and Physician Reports and data files. The *Bad Files* folder contains aliases (shortcuts) to files with QC flags.

Error Codes

Code	Error Message	Solution(s)
1	Could not acquire the user-requested [x number of population] events	<ol style="list-style-type: none">1 Decrease the Min Events to Acquire in Reagent Tools (Acquisition Target Info).2 Adjust acquisition stopping criteria in Events Preferences.3 Adjust acquisition target population gate or attractor at Manual Gate view, if necessary.4 Increase threshold if there is excessive debris.
2	Could not acquire the BDIS-preferred [500 bead] events.	<ol style="list-style-type: none">1 Adjust acquisition stopping criteria for user-requested number of events in Events Preferences.2 Visually inspect. Adjust gate to fully capture bead population within attractor at Manual Gate view, if necessary.3 Increase threshold if there is excessive debris.

General BD Multiset Software

Observation	Possible Cause	Recommended Solution
Disappearing dots on printouts	Wrong settings in Print Setup	Choose grayscale or color in Print setup, not black and white.
Differing CD3 counts within panel	Pipetting error	Use fully charged, calibrated electronic pipette (or equivalent) that delivers a precise amount of sample. Make sure sample does not drip from pipette tip during sample preparation.
	Tube run out of order, wrong reagent used, or different samples in same panel	Take care to run tubes in order. Do not mix samples in the same panel.
	Cell and/or BD Trucount bead settling	<ul style="list-style-type: none"> • Vortex tubes before acquiring. Resuspend cells if tubes have been sitting too long. • Adjust mix settings. • Restain sample, if necessary.
	Absolute count bead attractor missing bead population	Adjust bead attractor at Manual Gate view.

General BD Multiset Software (continued)

Observation	Possible Cause	Recommended Solution
Absolute count results extremely high	Donor-specific pathology	Re-stain sample. If problem occurs for absolute counts using hematology values, use reagent with BD Trucount tube.
	Pipetting error	Use fully charged, calibrated electronic pipette (or equivalent) that delivers a precise amount of sample. Make sure sample does not drip from pipette tip during sample preparation.
	Incorrect beads/pellet value(s) for absolute count beads in Lot IDs	Enter correct beads/pellet value(s); reanalyze.
	Beads not found. Reagent with BD Trucount tube selected, but sample prepared without BD Trucount tube.	Re-stain sample. Use reagent with BD Trucount tube.
	Cell and/or BD Trucount bead settling	<ul style="list-style-type: none"> • Vortex tubes before acquiring. Resuspend cells if tubes have been sitting too long. • Adjust mix settings. • Re-stain sample, if necessary.
	Absolute count bead attractor missing bead population	Adjust bead attractor at Manual Gate view.

BD Multiset Results

Observation	Possible Cause	Recommended Solutions
Cell populations outside attractors	Donor-specific anomaly	<ul style="list-style-type: none">• Manually adjust attractor and save as user-defined reagent (page 134).• If all samples show same anomaly, rerun BD FACSComp software and optimize settings for application (all but compensation). Rerun sample.

The figure displays three flow cytometry plots. The top-left plot shows SSC-H on the y-axis and CD45 PerCP on the x-axis. The top-right plot shows CD19 PE on the y-axis and CD3 FITC on the x-axis, with two distinct populations circled in black. The bottom plot shows SSC-H on the y-axis and CD3 FITC on the x-axis, with a population circled in black.

BD Multiset Results (continued)

Observation	Possible Cause	Recommended Solutions
T-cell counts lower than expected	Absolute count bead attractor capturing cell population	Manually adjust attractor.

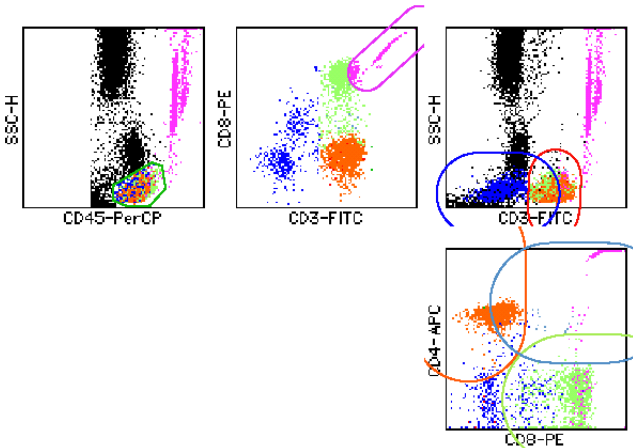

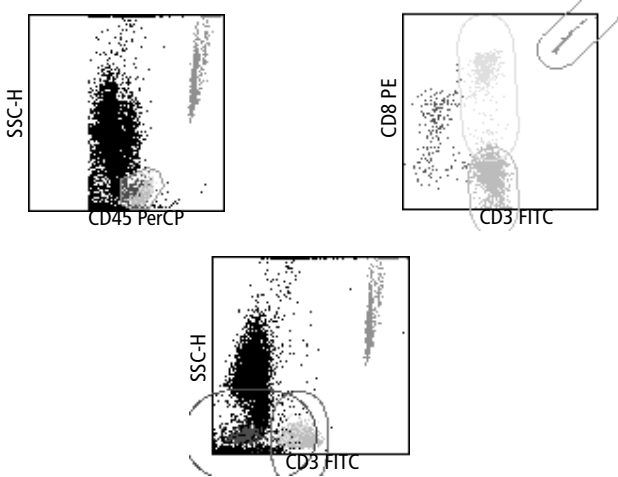

The figure displays four flow cytometry plots. The top-left plot shows SSC-H on the y-axis and CD45-PerCP on the x-axis, with a green gate around a population of cells. The top-middle plot shows CD8-PE on the y-axis and CD3-FITC on the x-axis, with a pink gate around a population. The top-right plot shows SSC-H on the y-axis and CD3-FITC on the x-axis, with a blue gate around a population. The bottom plot shows CD4-APC on the y-axis and CD8-PE on the x-axis, with a blue gate around a population. Colored lines (pink, blue, green, orange) connect the gates across the plots, indicating manual adjustments to the attractor.

BD Multiset Results (continued)

Observation	Possible Cause	Recommended Solutions
<p>Low side scatter for granulocytes in CD45 vs SSC plot; no distinct monocyte population</p>	<p>Aged blood and/or stained cells</p>	<p>Refer to the information provided by the reagent manufacturer for stability limitations.</p>
 <p>The figure contains three flow cytometry plots. The top-left plot shows SSC-H on the y-axis and CD45 PerCP on the x-axis. The top-right plot shows CD8 PE on the y-axis and CD3 FITC on the x-axis, with a gate drawn around the CD8+ population. The bottom plot shows SSC-H on the y-axis and CD3 FITC on the x-axis, with a gate drawn around the CD3+ population. All plots show a dense population of cells with low side scatter, indicating aged blood or stained cells.</p>		

BD Multiset Results (continued)

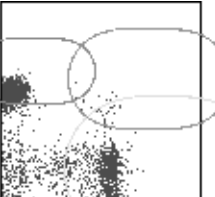
Observation	Possible Cause	Recommended Solutions
Fluorescence parameters dimmer than expected	Insufficient quantity of reagent during sample preparation	<p>For BD Biosciences reagents, re-stain using 20 μL reagent. Refer to the information provided by the manufacturer for staining instructions.</p> <p>For custom reagents, titrate antibody to determine sufficient amount.</p>
	Donor-specific anomaly	Wash sample before staining.
	 <p>SSC-H</p> <p>CD45 PerCP</p>	 <p>CD8 PE</p> <p>CD3 FITC</p>
	 <p>SSC-H</p> <p>CD3 FITC</p>	 <p>CD4 APC</p> <p>CD8 PE</p>

BD Multiset Results (continued)

Observation	Possible Cause	Recommended Solutions
Subset populations outside attractors for all samples	Compensation set incorrectly	Rerun BD FACSComp software, if necessary, and optimize settings for application (all except compensation). Rerun sample.
	Incorrect attractor position	Manually adjust attractor and save as user-defined reagent (page 134).

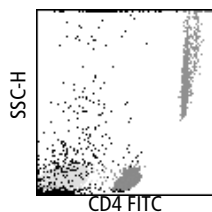
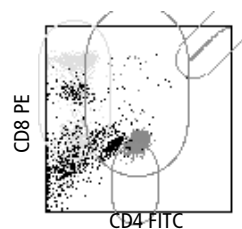
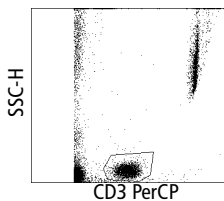

Loader Troubleshooting

Observation	Possible Causes	Recommended Solutions
Sample tube not pressurizing	Fluid mode not in RUN	Press RUN.
	Cracked sample tube	Replace the sample tube.
	No sheath pressure	<ul style="list-style-type: none"> • Verify the vent valve is forward. • Tighten the sheath cap. • Check that all sheath connectors are securely attached. • Check for leaks or cracks in the sheath reservoir. Replace, if needed.
	Outer sleeve missing or not seated in retainer	<ol style="list-style-type: none"> 1 Loosen the retainer. 2 Push up the outer sleeve until fully seated. 3 Tighten the retainer.
	Incorrect Tube Lifter Parameters	Check lifter parameters in Loader Manager software (page 180). Compare values to those provided by BD. If different, contact BD Biosciences.
	Difference between Loader sealing and manual sealing (Bal seal)	Reinstall Bal seal (page 186), and manually check tube sealing. If tube still does not seal, see Instrument Troubleshooting on page 190.
Worn Loader seal	Replace the seal (page 182). NOTICE Do this only after checking all other troubleshooting solutions.	

Loader Troubleshooting (continued)

Observation	Possible Causes	Recommended Solutions
Communication problem between Loader and computer	Loader power off	Switch on the Loader power, quit the software, and relaunch.
	Loose or damaged cable connecting Loader to computer	Shut down the computer and switch off the Loader power. Check all cable connections (page 181).
	Wrong communication port in Loader Manager software	In Loader Manager, choose Loader Manager > Preferences. Check that Print Port (2) is selected (page 181). If not, change the Preference, save, quit the software, and relaunch.
<i>Tube stuck</i> message displayed repeatedly	Firmware not clearing error message	Remove the Loader cover, even if tube does not appear to be stuck. Put the tube back into the rack. Re-install the cover and click Retry.
Vertical Timeout Error	Test tube not completely raised	Ensure the Loader drawer is completely shut and the tube is free of unnecessary labels or tape.
	Tube lifter hitting rack during ascent	Make sure the rack is properly engaged with the alignment guide pin. If problem persists, contact BD Biosciences.
	Spillage causing tube lifter to bind	Clean the tube lifter (page 184).
Invalid tube sequence	Incomplete scan due to interrupt	Remove and re-install the Loader cover.
	Wrong tubes installed	Check the Rack Manifest Report for proper tube locations; make sure cleaning tubes are in place, if required.

Worklist Manager Troubleshooting

Observation	Possible Causes	Recommended Solutions
BD CellQuest Pro panel unavailable	Experiment document in wrong folder	Place Experiment document(s) in BD Applications > Worklist Manager > CellQuest Experiments Folder.
	No panel selected	Open document in BD CellQuest Pro software and select panel in the Acquisition Browser.
BD Multiset assay unavailable	PanelReagentFile alias missing from ClinApps Info Folder or corrupted	<ul style="list-style-type: none"> • Make alias of PanelReagentFile and place in BD Applications > ClinApps Info Folder. • Re-install BD Multiset software.
Unlisted instrument settings file	Instrument settings in wrong folder	Move the file to BD Files > Instrument Settings Files.

Appendix A

Supplies and Replacement Parts

To order supplies and options, contact your local BD Biosciences representative.

This information is correct at the time of publication; for up-to-date information refer to our website (bdbiosciences.com).

Instrument Supplies

Accessory Kit

The instrument ships with the following items (kit part no. 343237).

Item	Reorder No.
Sheath filter (1)	343542
Sheath filter assembly (1)	02-61366-00
Air intake filter, 1.5-in. diameter (1)	343536
Hydrophobic air filter, 1.25-in. diameter (2)	343538
Barbed fitting 1/16 ID tubing (3)	343508
O-ring for SIP, .101 ID x .070W (5)	343620
O-ring for SIP, .239 ID x .070W	343610
O-ring for SIP, .364 ID x .070W (2)	343615
O-ring for SIP, .56 ID x .060W (1)	343612
Bal seal for SIP (5)	343509
O-ring for saline filter assembly (1)	343611
Sheath/waste gasket (2)	343663
Waste cap (1)	343662
Sheath cap (1)	344283
Disposable 38/400 white ribbed cap (5)	343533
Cotton-tipped applicator (1)	99-30122-00
DCM neoprene tubing (12 in.)	343585
DCM filter, 3-in. diameter (1)	343540
12 x 75-mm test tubes (bag of 125)	343675

Item	Reorder No.
Line declogger (1)	343583
Faucet container for saline (1)	343532
Grommet (1)	88-20158-00
2.5-m cordset for Australian power (10A C13)	335696
2.5-m cordset for European power (10A C13)	335697
2.5-m cordset for UK power (10A C13 R/A)	335698
6-ft cordset for US power (15A, 5-15P/320-C13)	337219

Other Replacement Parts

Item	Part No.
Consumable kit	343524
Sheath/waste reservoir	343665
Sheath level sensor assembly	02-60791-01S
Waste level sensor assembly	02-60790-01S
Air hydrophobic filter (1.25-in. diameter)	343538
Filter, laser air (12 x 16.5 in.)	343537
Silicone tubing	343666
Silicone tubing (per inch)	343664
Quick-disconnect O-ring	343618
Flat coated seal, 0.093 thick (for Loader)	19-66379-02
Flat coated seal, 0.125 thick (for Loader)	19-66379-01
Flat coated seal, 0.188 thick (for Loader)	19-66379-03
Loader cover assembly	02-61625-00

Item	Part No.
Carousel kit, carousels 1–4	332727
Carousel kit, carousels 5–8	332728
Carousel kit, carousels 9–12	332729
Carousel kit, carousels 13–16	332730

Consumables

Instrument Setup

Particle	Catalog No.	Purpose
BD Calibrite 3 kit	340486	SSC, FL1, FL2, FL3 setup and QC
BD Calibrite beads two-color kit	349502	SSC, FL1, FL2 setup and QC
BD Calibrite PerCP-Cy5.5	345036	FL3 Setup and QC
BD Calibrite PerCP beads	340497	FL3 setup and QC
BD Calibrite APC beads	340487	FL4 setup and QC

Reagents

Reagent	Catalog No.
BD FACST ^{Flow} sheath fluid	342003
BD FACS Clean	340345
BD FACS shutdown solution	334224
BD FACS Rinsing solution	340346
Monoclonal antibodies	a
BD FACST ^M lysing solution ^b	349202
Chlorine bleach ^c	N/A
BD Trucount Absolute Count Tubes	340334

a. Refer to the BD Biosciences catalog or the BD Biosciences website (www.bdbiosciences.com).

b. US Patent Nos. 4,654,312; 4,902,613; 5,098,849

c. Clorox® and other brand-name bleaches are preferred because they are filtered to remove particles and contain a known concentration of 5% sodium hypochlorite.

Labware

Item	Catalog No.
5-mL polystyrene test tubes, 12 x 75-mm (BD Falcon)	
• uncapped, 125 per bag	352052
• capped, 125 per bag	352054
• capped, 25 per bag	352058
• with cell-strainer cap, 25 per bag	352235
Absorbent pads (20)	343502

Appendix B

Technical Specifications

- Cytometer Specifications
- Loader Specifications

Cytometer Specifications

Dimensions	Height: 67.3 cm (26.5 in.), or 124.5 cm (49 in.) with cover open Width: 91.4 cm (36 in.) Depth: 61.5 cm (24.2 in.)
Workspace dimensions	Width: 151.4 cm (59.6 in.) Depth: 84.0 cm (33.1 in.)
Operational clearances, cytometer (space between unit and other objects or wall)	Left side: 30 cm (11.8 in.) for proper air flow and access to main circuit breaker Right side: 30 cm (11.8 in.) for proper air flow and access to power switch Back: 22.5 cm (8.9 in.) for proper air flow and opening of flow cell access door Top: 124.5 cm (49.0 in) above table top
Weight	109.1 kg (240 lb.)—cytometer only, excluding Loader and computer maximum ≤ 225 kg (≤ 490 lb.)—including Loader, printer, and workstation
Power requirements	120 VAC $\pm 10\%$ (50–60 ± 2 Hz) (transformer needed outside US) Current: 20A maximum
Power consumption	1725 W

Environment

Storage temperature	0–49°C (32–120°F)
Operating temperature	16–29°C (60–85°F)
Operating relative humidity	10–90% relative non-condensing
Noise level	≤62 dBA
Heat dissipation	5,000 BTU/hr
Facilities	No special room requirements

Performance

Fluorescence sensitivity	Estimated detection limit: 750 molecules of equivalent soluble fluorescein
Fluorescence resolution	Coefficient of variation in FL2-Area of <3%, full peak for PI-stained chicken erythrocyte nuclei
Forward and side scatter sensitivity	Resolution of fixed platelets from noise
Forward and side scatter resolution	Performance optimized for resolving lymphocytes, monocytes, and granulocytes
Carryover	≤ 0.3%

Optics

Laser Specifications

The following Class 3B lasers are mounted on the BD FACSCalibur instrument. Because the lasers are contained within the instrument, the BD FACSCalibur is a Class 1 (I) laser product.

Manufacturer	Model	Wavelength (nm)	Power (mW)
JDS Uniphase®	2111D-015SLBD	488	15
(optional second laser) Coherent®	HL6322G (Hitachi)	635	10

Excitation Optics

Optical platform	Fixed optical assembly
Beam geometry	Blue laser: 22 μm x 66 μm elliptical beam Red laser: 15 μm x 61 μm elliptical beam

Emission Optics

Collection lens	Optical gel-coupled to quartz cuvette
Fluorescence detection	4 PMT detectors (standard) + 1 optional 3 wavelengths detected from 488-nm laser: <ul style="list-style-type: none">• 530/30 nm• 585/42 nm• >670 nm One wavelength detected from optional 633-nm laser: 661/16 nm
Forward scatter detection	Photodiode with 488/10 bandpass filter
Side scatter detection	PMT with Brewster-angle beam splitter

Fluidics

General operation	Front panel control with three modes: RUN, STNDBY, and PRIME; standby mode for conserving sheath fluid when no sample tube installed
Fluid reservoirs	4-L sheath and waste containers in a pull-out drawer; level detectors for automatic indicating of low levels of sheath or high levels of waste
Sheath pressure	4.5 psi
Sample flow rates	Regulated and monitored pressure difference between sheath and sample; particle velocity in flow cell approximately 6 meters/second Low = 12 $\mu\text{L}/\text{min}$ Medium = 35 $\mu\text{L}/\text{min}$ High = 60 $\mu\text{L}/\text{min}$
Sample acquisition rate	2,000 events/sec
Recommended sample concentration range	Single-cell suspension of 1×10^5 to 2×10^7 particles/mL

Signal Processing

Workstation resolution	1,024 channels on all parameters
Data acquisition channels	Logarithmic amplifiers for SSC, FL1, FL2, FL3, and FL4 (with FL4 option), providing four-log decade range
Fluorescence compensation	Fluorescence spectral overlap can be compensated between FL1 and FL2, FL2 and FL3, and FL3 and FL4 (with FL4 option)
Pulse processing	Width and area measurements for discriminating doublets; available for all fluorescence parameters
Time	Can be correlated to any parameter

Loader Specifications

Rack compatibility	Loader carousels, numbers 1–16
Tube compatibility	
• Carousel	Up to 40 uncapped 12 x 75-mm tubes <ul style="list-style-type: none">• BD Falcon polystyrene test tubes• BD Trucount tubes
• Thickness of accumulated labels	≤5 mils (127 μm)
Tube sample volume	<1 mL

Connections

The following schematics show connections between the cytometer, computer, and Loader.

Figure B-1 Cytometer only

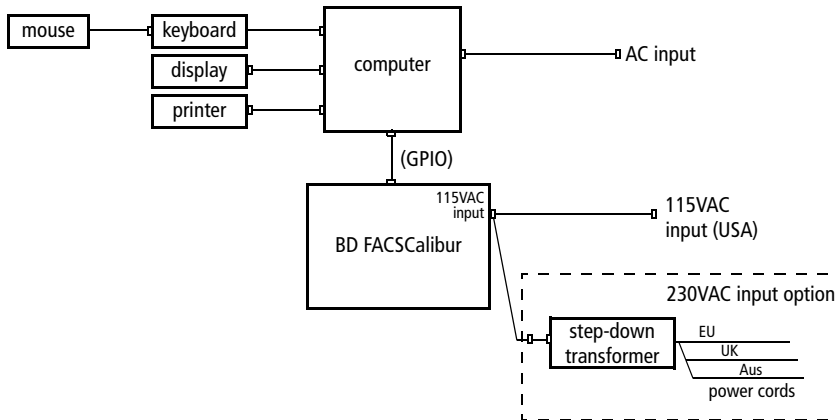
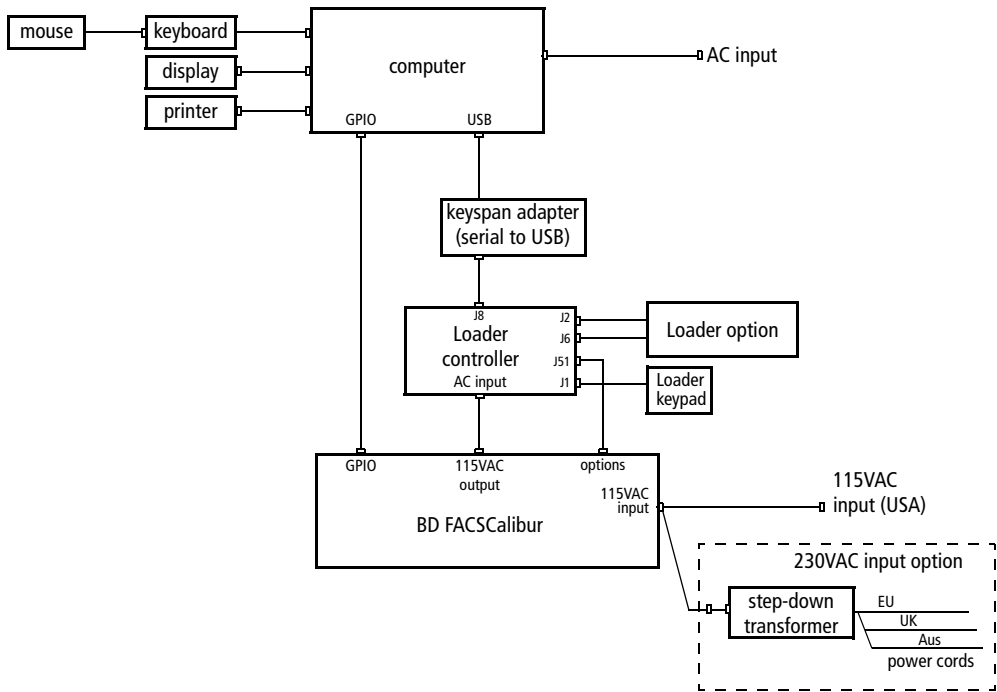

Figure B-2 Cytometer + Loader



Appendix C

Performance Data

- Accuracy
- Precision
- Linearity

NOTICE Detailed performance data for this instrument in combination with particular reagents can be found in the respective Instructions For Use provided with the reagent.

Accuracy

Lymphocyte subset percentage and absolute count enumerations with BD Multitest CD3/CD16+56/CD45/CD19 in BD Trucount Tubes were compared with results from BD Tritest CD3/CD16+56/CD45 or CD3/CD19/CD45 in BD Trucount Tubes.

Whole blood samples from normal and abnormal donors were collected at random at two clinical laboratories and evaluated in both systems. Regression statistics reported in Table C-1 indicate that the results are substantially equivalent.

Table C-1 Regression Analysis

Subset	n	R	Slope	Intercept	Range
Natural killer lymphocytes (%)	126	0.97	0.97	-0.85	3-40.0
B lymphocytes (%)	126	0.99	0.98	-0.25	0-59
T lymphocytes (%)	126	0.99	0.99	1.74	21.5-90.0
Natural killer lymphocytes (cells/ μ L)	126	0.96	0.92	-5.44	37-901
B lymphocytes (cells/ μ L)	126	0.98	0.95	1.77	3-877.6
T lymphocytes (cells/ μ L)	126	0.98	1.01	-10.18	100-2883

Precision

Two studies were conducted to assess within-specimen reproducibility: one using BD Multitest CD3/CD8/CD45/CD4 + BD Trucount reagent; the other using BD Multitest CD3/CD16+CD56/CD45/CD19 + BD Trucount reagent. All testing was performed on the BD FACSCalibur instrument.

For both studies, estimates of within-sample reproducibility were determined at 3 clinical laboratories from 5 replicates of each sample collected from normal and abnormal donors. Replicates which did not pass QC, and those where no data was acquired, were excluded from the study.

Means, standard deviations (SD), and/or coefficients of variation (CV) are provided for subset percentages and absolute counts greater than 100 cells/ μ L in Tables C-2 and C-3 and Tables C-4 and C-5.

Table C-2 Within-specimen reproducibility of subset percentages (BD Multitest CD3/CD8/CD45/CD4)

Subset	n ^a	Mean (%)	SD
Helper/inducer T lymphocytes (%)	46	26.1	0.85
Suppressor/cytotoxic T lymphocytes (%)	46	42.0	0.93
Total T lymphocytes (%)	46	72.0	1.06

a. Number of samples

Table C-3 Within-specimen reproducibility of absolute counts (BD Multitest CD3/CD8/CD45/CD4)

Subset	n	Mean (cells/ μ L)	SD	% CV
Helper/inducer T lymphocytes (cells/ μ L)	38	565.2	62.92	7.02
Suppressor/cytotoxic T lymphocytes (cells/ μ L)	46	687.8	54.02	6.79
Total T lymphocytes (cells/ μ L)	46	1219.9	101.57	6.34

Table C-4 Within-specimen reproducibility of subset percentages (BD Multitest CD3/CD16+CD56/CD45/CD19)

Subset	n	Mean (%)	SD
Natural killer lymphocytes	46	10.8	0.73
B lymphocytes	46	15.6	0.71
T lymphocytes	46	72.1	0.99

Table C-5 Within-specimen reproducibility of absolute counts (BD Multitest CD3/CD16+CD56/CD45/CD19)

Subset	n	Mean (cells/μL)	% CV
Natural killer lymphocytes	33	217	8.3
B lymphocytes	37	278	5.8
T lymphocytes	46	1217	4.7

Linearity

Linearity for the BD FACSCalibur system was assessed using the BD Multiset system and BD Multitest CD3/CD8/CD45/CD4 + BD Trucount reagent. The linear range of the BD Multitest/BD Trucount reagent system was evaluated through independent dilution of concentrated whole blood samples. The study assessed linearity within a WBC concentration of 0.2×10^3 to 29.7×10^3 WBC/ μ L and a lymphocyte concentration of 0.1×10^3 to 9.0×10^3 lymphocytes/ μ L.

Results were observed to be linear within the CD3⁺CD4⁺ range, the CD3⁺CD8⁺ range, and the CD3⁺ range.

Lymphocyte Subset	R	Slope	Intercept	Min. Abs Count (cells/ μ L)	Max. Abs. Count (cells/ μ L)
CD3	0.998	1.000	23.659	61	7721
CD4	0.999	0.997	16.815	34	4938
CD8	0.998	1.004	4.129	20	3731

Index

A

- absolute counts
 - bead lot IDs 127
 - calculating without Trucount 129
 - troubleshooting 201, 202
- accessory kit 212
- acquisition
 - & storage settings
 - global 101
 - tube-specific 108
 - controls 87, 99
 - document 150
 - gate 102
 - pausing (Worklist Manager) 163
 - troubleshooting 191
- adjusting
 - compensation
 - CellQuest Pro 96
 - FACSComp 74
 - FSC amp gain 90
 - PMTs
 - CellQuest Pro 95
 - FACSComp 71
 - SSC voltage 90, 125
 - threshold 90, 125
- air
 - bubbles, removing 57, 58
 - filter, cleaning 175

- analyzing data
 - by batch 119
 - CellQuest Pro 113
 - HLA-B27 software 146
 - Multiset 137
- assays
 - FACSComp 35, 62
 - settings, Worklist Manager 153
- assigning racks 158
- assistance, technical 189
- attractors, editing 134

B

- Bal seal, changing 176
- barcode scanner 128, 143, 156
- batch analysis
 - CellQuest Pro 119
 - HLA-B27 software 146
 - Multiset 137
- BD Inits, installing 27
- BDPAC 25, 27
- beads
 - Calibrite 64, 214
 - lot IDs 63, 64, 142
 - Trucount 127
- Browser
 - acquisition 87, 99
 - loading panels 106

- buttons
 - fluidics control 16
 - Loader keypad 21

C

- cables 181, 223

- calibration

- failure, HLA-B27 199
 - files 34
 - time-delay 72, 197

- Calibrite beads

- lot IDs 63, 142
 - preparing 64
 - target values 65

- carousel

- ID, SPA 161
 - rack 20
 - tube compatibility 222

- CellQuest Pro

- about 25, 28
 - acquisition controls 87, 99
 - analyzing data 113
 - batch analysis 119
 - files 30
 - formatting statistics 117
 - optimization 90
 - running samples 86
 - tools 28

- changing

- Bal seal 176
 - sample O-ring 178
 - sheath filter 173

- cleaning

- air filter 175
 - automatic, Loader 67, 68
 - daily 165
 - instrument 175
 - solutions 23, 169
 - tube lifter 184

- codes, Multiset error 200

- collection criteria 102

- color

- event 93, 114
 - histogram line 116

- compensation

- adjusting
 - CellQuest Pro 96
 - FACSCComp 74
 - automatic adjustment 73
 - troubleshooting 198

- components

- instrument 14
 - Loader 20
 - optics 18

- computer

- connections 223
 - requirements 23

- concentration, sample 221

- controls

- acquisition 87, 99
 - fluidics 16
 - power 22

- conventions, typographical xi

- counters, showing 110

- cover, Loader (removing) 68

- creating

- gates 29, 93, 114
 - histograms 116
 - panels 104
 - plots 29, 88, 114
 - quadrant markers 95

- customer support 189

- cytometer *See* instrument.

D

- daily cleaning 165

- Dock shortcuts 26

- drawer, fluidics 17, 56

E

- emptying waste 58
- errors
 - communication 181, 209, 223
 - Loader 68
 - time-delay calibration 72
 - vertical timeout 184, 209
- event color, changing 93, 114
- Experiment documents
 - about 30
 - enlarging 113
 - printing 118, 119
 - saving 100
 - saving as PDFs 30
 - setting up 86

F

- FACSCalibur *See* instrument.
- FACSCComp
 - about 25, 31, 61
 - assays 35, 62
 - files 34
 - optimization 79
 - preferences 33
 - reports 64, 77
 - running
 - manually 69
 - with HLA-B27 142
 - with Loader 66, 155
 - with Multiset 124
 - troubleshooting 195
- FACStation *See* software.
- FCS data files
 - about 30
 - saving 99, 110, 130, 144

files

- calibration (Calib) 34
- CellQuest Pro 30
- FACSCComp 34
- HLA-B27 software 50
- instrument settings 30
- Levey-Jennings 83
- Multiset 45
- statistics 30
- Worklist Manager 53
- filling sheath 56
- filters
 - about 18
 - air 175
 - sheath, changing 173
- FL4 option 19
- flow rate, sample 16
- fluidics
 - about 15, 221
 - control buttons 16
 - drawer 17, 56
 - priming 16, 58
- fluids
 - cleaning 169
 - required 23
- FSC amp gain 90

G

- gates
 - acquisition & storage 102
 - applying to plots 94
 - creating 29, 93, 114
 - Multiset 134
- global acquisition & storage 101

H

- hardware requirements 23
- histograms, creating 116
- HLA-B27 bead lot IDs 64, 142

- HLA-B27 software
 - about 25, 47
 - analyzing data 146
 - calibration failure 199
 - files 50
 - preferences 49
 - reports 140
 - running samples 139
 - Schedule document 50, 150

I

- Inspector 88
- installing
 - BDPAC software 27
 - racks 160
 - tubes 15
- instrument
 - cleaning 175
 - components 14
 - intended use 13
 - main power 22
 - maintenance 170, 175
 - modifying for non-Loader use 186
 - optics 18, 220
 - performance 225
 - QC particles 214
 - quality control 61
 - requirements 23
 - shut down 165
 - specifications 218
 - starting 55
 - status 112
 - supplies 212
 - troubleshooting 190
- instrument settings
 - downloading 82, 89
 - file 30
 - saving 98
 - tube specific 109
- intended use 13

K

- keypad, Loader 21

L

- Lab report
 - HLA-B27 145
 - Multiset 133
- labels
 - maximum thickness 222
 - parameter 103
- labware 23, 215
- lasers 18, 220
- Levey-Jennings files 83
- lifter settings 180
- Loader
 - check seal 68
 - clean cycle 67, 68
 - components 20
 - connections 181, 209, 223
 - error 68
 - installing racks 160
 - keypad 21
 - maintenance 179
 - manual operation 21
 - mixing 21, 154
 - opening cover 68
 - power 21
 - rack 20, 222
 - running FACSCComp 66, 155
 - seal, replacing 182
 - shutting down 166
 - software 51
 - specifications 222
 - starting 55
 - status 151
 - troubleshooting 208
 - tube lifter settings 180
 - tube positions 67, 158
 - tube stuck 209

- Loader Manager
 - about 25, 51
 - status window 151
- log, QC 83
- lot IDs
 - Calibrite 63, 142
 - HLA-B27 calibration 64, 142
 - Trucount 127

M

- maintenance
 - Loader 179
 - scheduled 170
 - unscheduled 175
- manual
 - compensation adjustment 74
 - PMT adjustment 71
- mixing, Loader 21, 154
- Multiset
 - about 25, 39
 - analyzing data 137
 - error codes 200
 - files 45
 - manual gating 134
 - optimization 125
 - preferences 41
 - QC values 132
 - reports 123
 - results, troubleshooting 203
 - running samples 121
 - Schedule document 45, 150
 - test preferences 126
 - tools 43
 - troubleshooting 200

O

- optics, instrument 18, 220

- optimization
 - about 61
 - downloading settings 82, 89
 - with CellQuest Pro 90
 - with FACSCComp 79
 - with Multiset 125
- O-ring, changing 178

P

- panels
 - creating 104
 - loading into Browser 106
- parameter labels 103
- pausing acquisition (Worklist Manager) 163
- Physician report 136
- plots
 - applying gates 94
 - associating with tubes 107
 - creating 29, 88, 114
- PMTs
 - adjusting
 - CellQuest Pro 95
 - FACSCComp 71
 - automatic adjustment 69
 - unable to set 195
- power
 - instrument 22
 - Loader 21
- preferences
 - FACSCComp 33
 - HLA-B27 software 49
 - Multiset 41
 - Worklist Manager 53
- priming fluidics 16, 58
- printing
 - Experiment documents 30, 118, 119
 - Rack Manifest report 159
 - reports 33, 41, 49
 - Target Value Log file 66

Q

- quadrant markers 95
- quality control (QC)
 - instrument 61
 - log 83
 - message codes 200
 - particles 214
 - values, Multiset 132

R

- Rack Manifest report 159
- racks
 - assigning 158
 - carousel 20, 222
 - editing assignments 159
 - installing 160
- reagents
 - ordering 215
 - requirements 23
- registering software 26
- removing
 - air bubbles 57, 58
 - Loader cover 68
- replacing Loader seal 182
- reports
 - FACSComp 64, 77
 - HLA-B27 software 140
 - Lab
 - HLA-B27 145
 - Multiset 133
 - Multiset 123
 - Physician 136
 - printing 33, 41, 49
 - Rack Manifest 159
 - Summary
 - HLA-B27 146
 - Multiset 137
 - Worklist Manager 162
- requirements, system 23

- rerunning samples 164
- RUN mode 16

S

- sample
 - concentration 221
 - flow rate 16
 - information
 - HLA-B27 143
 - Multiset 128
 - Worklist Manager 156
 - injection port (SIP) 15
 - O-ring, changing 178
- Sample Prep Assistant (SPA)
 - importing Worklists 156
 - unique carousel ID 161
- samples, running
 - CellQuest Pro 86
 - HLA-B27 software 139
 - Multiset 121
 - rerunning 164
 - Worklist Manager 160
- saving
 - data
 - CellQuest Pro 99, 110
 - HLA-B27 144
 - Multiset 130
 - Experiment documents 100
 - FACSComp reports 64, 77
 - HLA-B27 reports 140
 - instrument settings 98
 - Multiset reports 123
 - Worklists 155, 158
- Schedule document
 - HLA-B27 50, 150
 - Multiset 45, 150
- scheduled maintenance 170
- Selection tool 28

- Sensitivity Test
 - about 76
 - failure 199
- settings
 - acquisition & storage 101
 - tube-specific 108
- sheath
 - filter, changing 173
 - refilling 56
- shortcut, software 26
- shutting down instrument 165
- SIP *See* sample injection port.
- Snap-To gate 114
- software
 - See also individual application names.*
 - about 25
 - Loader 51
 - registering 26
 - requirements 23
 - shortcut 26
- solutions, cleaning 169
- spare parts 213
- specifications
 - cytometer 218
 - Loader 222
 - performance 225
- SSC voltage, adjusting 90, 125
- starting instrument 55
- statistics
 - file 30
 - formatting 117
- status
 - instrument 112
 - Loader 151
- STNDBY mode 16
- storage gate 102
- Summary Reports
 - FACSComp 77
 - HLA-B27 146
 - Multiset 137
 - Worklist Manager 162

- supplies, instrument 212

T

- Target Value Log file 36, 66
- target values 65
- technical assistance 189
- test preferences, Multiset 126
- threshold, adjusting 90, 125
- time-delay calibration
 - about 72
 - failure 197
- tools
 - CellQuest Pro software 28
 - Multiset 43
 - Selection 28
- transformer 22
- troubleshooting
 - absolute counts 201, 202
 - acquisition 191
 - communication errors 181, 209, 223
 - compensation 198
 - FACSComp 195
 - HLA-B27 calibration 199
 - instrument 190
 - instrument status 112
 - Loader 208
 - Multiset 200
 - Multiset results 203
 - PMT settings 195
 - sensitivity test 199
 - time-delay calibration 197
 - tube pressurization 182, 208
 - vertical timeout error 184, 209
 - Worklist Manager 210
- Trucount tube lot IDs 127
- tube lifter
 - cleaning 184
 - settings 180

- tubes
 - associating with plots 107
 - installing 15
 - Loader rack positions 67, 158
 - Loader-compatible 222
 - not pressurizing 182, 208
 - sample volume 222
 - specific settings 108
 - stuck (Loader) 209
- typographical conventions xi

U

- unscheduled maintenance 175

V

- vertical timeout error 184, 209

W

- waste, emptying 58
- windows, showing hidden 87
- Worklist Manager
 - about 25, 51
 - assay settings 153
 - files 53
 - pausing acquisition 163
 - preferences 53
 - running samples 160
 - troubleshooting 210
- Worklists
 - importing SPA 156
 - saving 155, 158